



Tarifa de precios / **Price list**

ILUMINACIÓN VIAL,
RESIDENCIAL Y URBANA

**STREET LIGHTING,
RESIDENTIAL AND
URBAN**

58



58

ILUMINACIÓN VIAL
RESIDENCIAL Y
URBANA

STREET LIGHTING
RESIDENTIAL AND
URBAN

Tarifa de precios
Price list

secom
here comes the light

Las instrucciones de montaje, certificados de calidad, fichas técnicas y archivos eulumdat, se encontrarán disponibles en formato PDF para su descarga en nuestra página web:

www.secom.es

Assembly instructions, quality certificates, technical specification sheets and eulumdat files available to download from our site:

www.secom.es



SECOM ILUMINACIÓN S.L.

Polígono Industrial La Estrella. C/ Marte 18-21
30500 Molina de Segura (Murcia) Spain
Buzón de Correos nº11
Tlf.: 968 80 12 11 • Fax.:968 89 10 48
secom@secom.es

Dpto.Exportación
Tlf.: ++34-968 80 16 88 • Fax.: ++34-968-60 34 49
export@secom.es

www.secom.es

Oficinas centrales Molina de Segura (Murcia, España).
Head Office Molina de Segura (Murcia, Spain).



Iluminar es habilidad, tecnología e innovación así como sensibilidad, originalidad y alma.

Secom Iluminación, es una compañía que nace en 1989 con la firme convicción de aportar nuevos valores a cada uno de los eslabones que forman la cadena del mercado de iluminación.

Secom Iluminación centra sus actividades en el diseño, fabricación y comercialización de distintos tipos de luminarias y fuentes de luz, así como los últimos y novedosos desarrollos en tecnología LED.

Secom, rápidamente se sitúa como empresa líder del sector de Iluminación a nivel europeo, gracias a la cercanía que tiene con arquitectos, ingenieros, distribuidores, instaladores y clientes finales escuchando y recogiendo cada una de sus sugerencias e incorporándolas en nuestra cadena de diseño, para crear luminarias que se adapten de manera perfecta a cada una de sus necesidades. Actualmente Secom Iluminación vende en los cinco continentes, generando entre directos e indirectos más de 500 puestos de trabajo.

Secom, en sus instalaciones centrales de 14.900 m² en Molina de Segura (Murcia, España), une todos los procesos productivos, junto con un gran stocks de componentes involucrados en la fabricación de aparatos de iluminación, para poder conseguir una gran flexibilidad y un inmejorable plazo de entrega.

Secom centra su filosofía de trabajo en conseguir luminarias de altísima calidad, con componentes europeos de primeras marcas para conseguir una gran fiabilidad, con unos precios ajustados.

Secom da suma importancia a reducir los gastos de tiempo y almacenaje de sus distribuidores, por tanto, cuida su paquetería en la que concentra un diseño atractivo, con líneas poliédricas fácilmente apilables y abundante información técnica. También trata en cada una de sus luminarias de reducir el tiempo de instalación, para facilitar y reducir el coste de mano de obra por parte del instalador electricista. Finalmente, tanto para prescriptores como para el cliente final, cuida de manera especial el diseño estético de la luminaria, el control de la luz y su eficiencia.

Lighting is skill, technology and innovation but also sensitivity, originality and soul.

Secom Iluminación was founded in 1989, and committed to adding value at every stage of the lighting market

Secom Lighting focuses its activities in the design, manufacture and marketing of various types of fittings and light sources.

Secom has reached a leading position in the European lighting industry, thanks to its closeness with architects, engineers, wholesalers, installers and end customers, its listening and picking up each of their suggestions and its incorporating them into the design plans, eventually creating fittings that perfectly meet all wants and needs. Secom currently sells its fittings all over the world, generating directly and indirectly above 500 jobs.

Secom, in its 14,900-sqm facilities located in Molina de Segura (Murcia, Spain), carries out all production processes, and keeps large stocks of components involved in the manufacture of lighting equipment, in order to achieve greater flexibility and a reasonable delivery time.

Secom business philosophy focuses on getting high quality fittings, with Europe's top brand components for high reliability, and reasonable prices.

Secom attaches great importance to reduce time and storage costs of its distributors, therefore, carries out a careful and attractive packaging process, making the piling process easier thanks to its polyhedral lines and plenty of technical information. The fittings are also intended to take a short installation time, thus reducing labour cost. Finally, for both prescriptors and final clients, Secom especially cares for the esthetic side of the fitting, light control and efficiency.



Video corporativo Secom
Corporate Video Secom



Secom está situado en la vanguardia de la tecnología, con un potente departamento I+D+i, que en los últimos años ha venido incorporando la última y más moderna maquinaria para el desarrollo y fabricación de luminarias. Una de sus últimas adquisiciones han sido todos los equipos necesarios para poder fabricar y ensamblar toda la tecnología de circuitos y luminarias de LED. Con esto se pretende hacer frente a la cada vez más importante demanda de este tipo de luminarias y fuentes de luz, cada vez más eficientes y más respetuosas con el medio ambiente.

Secom, at the forefront of technology with a professional I+D+i department, has incorporated the latest and most modern machinery for the development and manufacture of light fittings. One of its recent acquisitions is the necessary equipment to manufacture and assemble the entire LED circuit and LED lights, enabling the company to deal with the increasingly strong demand for this type of fittings, more and more efficient and environmentally friendly.

OPCIONES DE EQUIPAMIENTO / ACCESORIES

Tecnología LED

LED tiene su origen en siglas inglesas Lighting Emitting Diode (Diodo emisor de Luz).

Secom Iluminación solo utiliza primeras marcas de componentes semiconductores como Osram (Germany) en luminarias, para crear soluciones que permiten desarrollar proyectos de iluminación que se adaptan a todas las necesidades.

Brindamos a nuestros clientes la posibilidad de elegir entre un amplio abanico de lentes secundarias simétricas, asimétricas o con diferentes grados de apertura según las aplicaciones de uso, la creación de ambientes o efectos de luz.

Secom Iluminación diseña sus productos para permitir la sustitución rápida y eficiente de cualquiera de los componentes fungibles u otros que puedan ser susceptibles de cambio tanto durante el periodo de garantía como con posterioridad, dando una larga vida a los modelos de luminarias.

Controles Integrados de Ahorro

En cumplimiento estricto de la normativa vigente Secom Iluminación ofrece sistemas de regulación en iluminación dinámica adecuada a cada instalación para facilitar la movilidad de los ciudadanos en condiciones de confort y máxima seguridad, consiguiendo ahorros adicionales en el consumo energético.

Ref. DRC Regulación en cabecera de la tensión de red

Este sistema de regulación permite utilizar luminarias LED en instalaciones existentes con regulación en cabecera de la tensión de red, regulando las luminarias sin modificar la instalación.

Driver Regulable Programado Cronodimmer (DRP / DN)

Secom Iluminación integra diferentes sistemas de regulación autónoma que permite a la luminaria hacer regulación en cumplimiento de la normativa vigente para instalaciones en las cuales no existe ningún tipo de regulación.

Ref. DRP

Driver programado de fábrica permite hacer hasta un máximo de 5 niveles en función de la media noche virtual o desde el encendido adaptándose totalmente a las necesidades del cliente.

Ref. DN

Driver programable a través de los encendidos, facilita la modificación de la programación realizando encendidos desde el cuadro de mando. Realiza regulación en 100%, nivel reducido y 100%.

Ref. DR Regulación 1-10V

Driver con regulación 1-10V para integrar en un futuro telegestión o hacer regulación con línea de mando a través de una señal 1-10V.

Ref. DRD Regulación Dali

Driver regulable para integrar posteriormente telegestión con regulación Dali o regulación con línea de mando a través de señal Dali obteniendo un control personalizado del alumbrado.

Telegestión

Secom Iluminación incorpora sistemas de telegestión inteligente para iluminación por radiofrecuencia o PLC permitiendo control punto a punto y la monitorización a tiempo real de cada luminaria para un control total o sistemas más económicos de telegestión y monitorización a nivel de cuadro de mando.

LED Technology

LED word is the acronym of Lighting Emitting Diode.

Secom Iluminación makes use only of first brands semiconductors in his lighting products, as Osram (Germany), in order to create solutions which allow to develop lighting projects for all needs.

We offer our clients a choice of a wide range of secondary lens, symmetrical, asymmetrical, or with different opening degrees depending on their needs and applications, like different uses or activities, lighting effects, atmosphere creation,...

Secom Iluminación designs his products to allow fast and efficient repairs and replacements of any fungible or subject to change components, both during the warranty period and subsequently, enlarging lamps life.

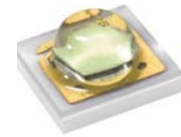

Saving Integrated controls

In strict compliance with current regulations, Secom Iluminación provides adequate control systems in dynamic lighting for each installation to facilitate the mobility of citizens in terms of comfort and maximum safety, achieving additional savings in energy consumption.

Ref. DRC Regulation at the head of the line voltage

These adjustment system, allows using LED lighting in existing facilities with regulation in the head of the line voltage, regulating the lights without modifying the installation.

Scheduled Adjustable Driver Cronodimmer (DRP / DN)

Secom Iluminación integrates different autonomous regulation systems that allows the luminaire to regulate in compliance with current regulations for facilities in which there is no type of regulation.

Ref. DRP

Configured Driver in factory that allows up to 5 levels based on the virtual night or from power fully adapted to customer needs.

Ref. DN

Programmable Driver through switches, that facilitates the modification of programming lighted from the dashboard. It makes adjustment to 100%, reduced level, and 100%.

Ref. DR Regulation 1-10V

Driver with 1-10V control for integrating in the future the remote management or to do the regulation with control line through a 1-10V signal.

Ref. DRD Regulation Dali

Dimmable driver to integrate subsequently remote management with Dali or regulation with control line signal through Dali, getting a personalized lighting control.

Remote management

Secom Iluminación, incorporates intelligent remote management systems for lighting by radio or PLC, allowing point to point control and real time monitoring of each luminaire for a total control or cheaper systems of remote management and cheaper monitoring to the level of dashboard.

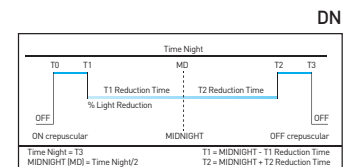
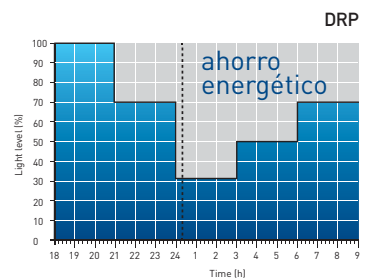
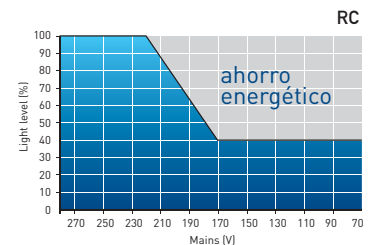

Ref. **G** Balasto magnético

Balastos robustos, de larga duración y económicos. Garantizan un funcionamiento eficaz de las lámparas junto a un condensador capaz de corregir el factor de potencia.

Ref. **BE** Balastos electrónicos de descarga

Equipos electrónicos compactos para lámparas de descarga en aplicaciones de alumbrado exterior. Mediante el uso de los equipos electrónicos para lámparas de descarga se puede lograr un 15% de ahorro energético gracias a que las pérdidas térmicas son menores que con los equipos tradicionales.

Además de ser más compactos y sencillos, los equipos electrónicos estabilizan la tensión y controlan el funcionamiento de cada lámpara, lo que supone un posible alargamiento hasta de un 30% de la vida útil. Para más seguridad y confort los equipos electrónicos de descarga desconectan la lámpara antes de que comience a dar posibles fallos como parpadeos, excesivo calentamiento o variaciones del tono de color.

Ref. **RLM** Regulación doble nivel con línea de mando en descarga

Este sistema de regulación permite hacer regulación de doble nivel en instalaciones con línea de mando en luminarias de descarga VSAP o HQL.

Ref. **RSL** Regulación doble nivel sin línea de mando en descarga

Este sistema permite hacer regulación de doble nivel en luminarias de descarga en instalaciones que no existe ningún tipo de regulación.

DURABILIDAD Y ROBUSTEZ / DURABILITY AND STRENGTH

Secom Iluminación incorpora de manera estándar protección individual para cada semiconductor de potencia media, ante el fallo de uno de estos semiconductores el diodo protector cierra el circuito permitiendo al resto de LED funcionen en régimen nominal. Este sistema además protege de descargas electrostáticas producidas en el interior de la luminaria.

Ref. **3390**

Protección sobretensiones transitoria básica 4KV en todas las luminarias industrial o de alumbrado público, opcionalmente 10KV.

Ref. **DRPNTC** Driver programable y sonda Tª NTC

Driver programable hasta 5 niveles con control de temperatura NTC en la placa de LED.

El control de temperatura a través de sonda NTC permite controlar la temperatura de funcionamiento de los semiconductores a tiempo real y controlar la intensidad lumínica en el caso de una eventual subida de temperatura con el fin de garantizar la vida útil de la luminaria.

Fácil instalación, luminarias industriales, viales y residenciales incorporan conector estanco aéreo para conexiones eléctricas de la luminaria sin necesidad de abrirla, garantizando el IP desde fábrica y minimizando los costes y tiempos de montaje.

Ref. **AM** Pintura especial ambiente marino.

Acabado de pintura especial protección de ambientes marinos con clasificación según ISO 12944-2.

Bio-NOx®.

Bio-NOx es una pintura fotocatalítica capaz de eliminar o reducir los compuestos de nitrógeno del aire a través de una función fotocatalítica que transforma dichos NOx, en nitratos inocuos para el medio ambiente, purificando así el aire que respiramos.

La eficacia del producto ha sido contrastada por diversos organismos, tanto públicos como privados, y representa un sistema activo para la mejora de la calidad del aire en las ciudades. La máxima eficacia del producto está probada aplicando el Bio-NOx sobre un poliéster blanco RB-9159.

Si el producto base es un color distinto, la eficacia disminuye y el aspecto estético debe considerarse especialmente, al ser el +Bio-NOx un barniz semitransparente mate. Secom Iluminación incorpora a petición del cliente en sus productos, la pintura Bio-NOx.

Ref. **G** Control Gear

Strong, long-life and economic ballast. It guarantees lamps efficiency and it is provided with a capacitor that corrects the power factor.

Ref. **BE** Electronic discharge ballast

Electronic equipment for discharge lamps in outside lighting applications. This equipment produce up to 15% of energy savings, because it is more efficient than classical equipments and thermal-losses are reduced.

Beside being more reduced and simple, It also stabilizes the voltage and controls the operation of each lamp, enlarging lamps-life up to 30%. In order to get more comfort and safety, electronic discharge ballast switch off the lamp before it could starts to give potential failures, such as blinking, excessive heating or variations in color tone.

Ref. **RLM** Double Level Regulation with control line in glow lamps

This control system allows two-level regulation in installations with control line VSAP or glow lamps HQL.

Ref. **RSL** Dual level regulation without control line in glow lamps

This system allows dual level regulation in glow lighting for installations in which there is no type of regulation.

Secom Iluminación mounts standardly individual protection for each half-power semiconductor, in order to solve the failure of one of these semiconductors, the protection diode completes the circuit allowing to the rest of LED, operate at rated. This system also protects against electrostatic discharges inside the luminaire.

Ref. **3390**

4KV basic transient surge protection in all industrial and street lighting fixtures, optionally 10KV.

Ref. **DRPNTC** Prog. driver & NTC control

Programmable driver up to 5 levels with NTC temperature control in the LED board.

Temperature control via NTC sensor can control the operating temperature of semiconductor in real time and it can control the light intensity in the case of a possible rise in temperature in order to ensure the lifetime of the luminaire.

Easy installation, industrial light fittings, street lights and residential light fixtures also incorporate an air-tight connector for electrical connection of the luminaire without opening it, ensuring IP of factory and minimizing the costs and production time.

Ref. **AM** Special painting for marine environment

Special paint finish protection for marine environments with classification according to ISO 12944-2.

Bio-NOx®.

Bio-NOx is a photocatalytic paint which is able to eliminate or reduce nitrogen compounds that exist in the air through a photocatalytic function, that transforms these NOx into safe nitrates, thus purifying the air we breathe.

This product efficacy has been proved by different agencies, both public and private, and it is an active system to improve the air quality in our cities. The maximum efficiency of this product has been tested using the Bio-NOx on a white polyester RB-9159.

If the base product is in a different color, its efficiency decreases, and aesthetics should be particularly considered because the Bio-NOx is a semi-matt varnish. Secom Iluminación incorporates in its products Bio-NOx painting if it is requested.



RECOMENDACIONES PARA LA INSTALACIÓN

INSTALLATION RECOMMENDATIONS

SIMBOLOS FUNCIONALES FUNCTIONAL SIMBOLOGY

ILUMINACIÓN VIAL / STREET LIGHTING



Autopistas y autovías / Highways



Carreteras / Roads



Vial funcional / Service ways



Tunel / Tunnels

ILUMINACIÓN URBANA / URBAN LIGHTING



Calles y avenidas / Streets and Avenues



Residencial / Residential



Peatonal / Pedestrian ways



Parques y jardines / Parks and gardens



Monumental / Monumental illumination



Señalización / Sign lighting

ILUMINACIÓN GRANDES ÁREAS BIG AREAS LIGHTING



Deportivo Exterior / Outdoor sports zones



Grandes superficies / Big surfaces



Deportivo interior / Sports indoor lighting



Estacionamiento / Parking zones



Industrial / Industrial



Almacenes / Department stores



Comercial / Shopping malls

SIMBOLOS TÉCNICOS TECHNICAL SIMBOLOGY



Superficie expuesta al viento (horizontal)
Surface exposed to wind (horizontal)



Superficie expuesta al viento (vertical)
Surface exposed to wind (vertical)



Baja contaminación lumínica
Short light pollution

FHS

Flujo en el Hemisferio Superior del total eficaz / Upper hemisphere flow from total effective flow
El tanto por ciento de la luz producida por la luminaria que se proyecta hacia el cielo a partir del nivel del horizonte y que, por tanto, es luz perdida.
Light percentage produced produced in the focus that is projected to the sky from the horizon level, which is lost light.

E1	<1%
E2	1% - 5%
E3	5% - 15%
E4	15% - 25%



Ancho - Width = A / W
Largo - Length = L / L
Alto - Height = Al / H



Peso
Weight

Iluminación vial
Street lighting



Ecodut K2 LED ◀
12

Dural ◀
14

Protek Q2 City LED ◀
Protek Q2 City LED duo
Protek Q2 City LED Trio
16

Konak City LED ◀
22

Ecodut LED ◀
Ecodut
24

▶

ÍNDICE / INDEX

Iluminación residencial
Residential lighting



Auris LED ◀
Auris LED suspensión
30



Kloss city LED ◀
32



Protek City LED ◀
Protek City LED duo
Protek City LED Trio
34



Ripa LED ◀
Ripa
38



Ray Ben LED ◀
Ray ben
42

Iluminación urbana
Urban lighting



Ura LED ◀
Ura
48



Regal LED ◀
Regal
54

Grupos ópticos LED
LED optics groups



Ura LED ◀
Regal LED
Ecodut LED
Ripa LED
Ray Ben LED
60

▸ ILUMINACIÓN
VIAL

▸ STREET
LIGHTING





ECODUT K2 LED

Grado de protección **IP65** / Índice de protección antivandálico **IK08**

Material:	Cuerpo fabricado en aluminio inyectado, granallado y con recubrimiento de pintura al horno de poliéster sin TGIC resistencia para exterior. Opcionalmente se suministra con pintura especial con resistencia para ambiente marino.
Óptica:	Ópticas de 80°/150° incluidas en las lámparas LED. Disponibles varias ópticas asimétricas Ledil (Finlandia). Cierre en metacrilato (PMMA) para LED de gran paso de luz y resistencia UV.
Alimentación:	Driver incluido en todos los modelos, factor de potencia >0,95. Puede suministrarse opcionalmente con driver 1-10V, Dali, driver regulable programable 5 niveles sin línea de mando, doble nivel sin línea de mando, regulación en cabecera, regulación de movimiento o driver para funcionamiento a 12Vdc.
Lámparas:	Módulo compuesto por LED Osram Oslon SSL con una potencia 29,4w, 45,4w, 61,6w, 100w, 150w y 200w. Disponible en 3000°K, 4000°K o 5700°K. PCB en aluminio de alta pureza 1,6mm lacada en blanco con conectores rápidos. Protección interna con diodo individual para cada LED. Sobretensiones estándar del driver 4KV, bajo pedido sobretensiones 10KV.
Vida útil:	L70B50 60.000 horas.
Instalación:	Sobre columna o báculo, luminaria ajustable en orientación. Ø 60mm. (Otras dimensiones bajo pedido). Un conector eléctrico rápido de 3 o 5 polos, IP66, permite instalar la luminaria sin necesidad de abrirla.
Temp. ambiente:	-20°C a 40°C. Se puede solicitar con sonda de temperatura NTC.
Colores:	Gris sablé similar RAL 7012. Disponible en otros colores RAL bajo pedido.

ECODUT K2 LED

Protection degree **IP65** / Impact protection index **IK08**

Material:	Body made of injected aluminum, blasting and polyester thermo painted without TGIC. Outdoor resistance. Optionally it can be supplied with special paint resistant to marine environment.
Optics:	80° / 150° optics included in LED lamps. Available several asymmetric optics LEDIL brand (Finland). Closure in methacrylate (PMMA) for good light path LEDs and UV resistance.
Supply:	Driver included for all models, power factor > 0.95. It can be provided optionally with 1-10V dimmable driver, Dali dimmable driver, programmable dimmable driver with 5 levels without control line, double power level with no line of command, header regulation, regulation with motion sensor and driver to work with 12Vdc.
Lamps:	Osram LEDs module composed by Oslon SSL with a total power of 29,4w, 45,4w, 61,6w, 100w, 150w y 200w. Available in 3000°K, 4000°K or 5700°K. High purity aluminium PCB from 1,6 mm. lacquered in white colour with quick connectors.
Protections:	Internal protection with individual diode for each LED. Standard Surge protector of 4KV driver. Available 10KV surge on request.
Lifespan:	L70B50 60.000 hours.
Installation:	To mount on column or crosier. Luminaire adjustable in several orientation degrees. Ø 60mm. (Other dimensions on request). A quick connector of 3 or 5 poles, IP66, it allows the installation without opening the luminaire.
Ambient temp.:	-20° C to 40° C. Optionally supplied with NTC temperature probe.
Colours:	Sablé gray colour similar to RAL 7012. Available in other RAL colours on request.



Vídeo instalación
Video installation



Ecodut K2 LED - Óptica simétrica 150°
Ecodut K2 LED - Symmetric optics 150°



Incluye driver y lámparas LED
Includes driver and LED lamps

Ref.	Colour / Colour	Lumens	W	€	RAEE lum.
3370 58 29 85	Gris / Gray	4479	29,4W	459,90	0,60
3370 58 45 85	Gris / Gray	5823	45,4W	479,90	0,60
3370 58 61 85	Gris / Gray	7839	61,6W	510,90	0,60
3370 58 10 85	Gris / Gray	9632	100W	587,70	0,60
3370 58 15 85	Gris / Gray	14336	150W	677,70	0,60
3370 58 20 85	Gris / Gray	19264	200W	782,70	0,60

* Se suministra de manera estándar con lámpara 5700°K.

* Standardly supplied with 5700°K LED lamp.

OPTIONS LED	Ref. 83	Ref. 84	Ref. 85
CRI>80 / Temp. de color / Colour temperature	3000°K	4000°K	5700°K
Lum 29,4w	3047	4116	4479
Lum 45,4w	4115	5544	5823
Lum 61,6w	5180	7000	7839
Lum 100w	8202	8815	9632
Lum 150w	12207	13120	14336
Lum 200w	16404	17630	19264

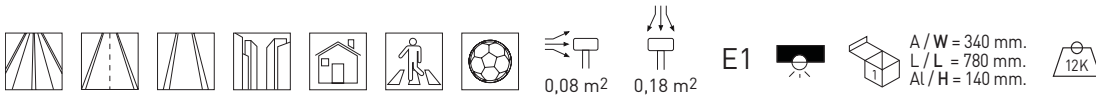
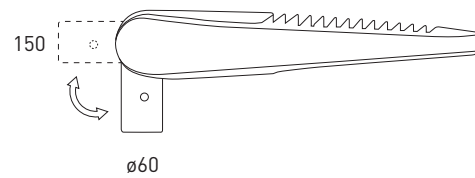
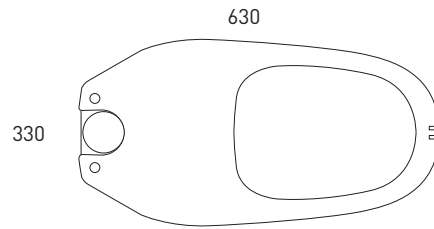

Incremento respecto al driver / Rough price increase of accessories		29,4w	45,5w	61,6w	100w	150w	200w
Ref. DR	Driver regulable 1 - 10v / Dimmable driver 1 - 10v	19,90	19,90	105,00	90,00	95,00	225,00
Ref. DRD	Driver regulable Dali / Dimmable driver Dali	90,00	30,00	30,00	55,00	55,00	40,00
Ref. DRP	Driver programable / Programmable driver	71,30	94,80	94,80	94,80	94,80	225,00
Ref. DRPNTC	Driver prog. y sonda T° NTC / Prog. driver & NTC control	87,10	110,60	110,60	110,60	110,60	240,80
Ref. DN	Regulación doble nivel / Double level dimmable	40,00	42,00	160,00	-	-	-
Ref. DRC	Regulación en cabecera / Regulation at the head	71,30	94,80	94,80	94,80	94,80	225,00
Ref. DMR8	Regulación de movimiento / Motion detector	75,00	75,00	170,00	150,00	150,00	280,00
Ref. 4160	Driver para funcionam. a 12Vdc. / Driver for 12Vdc operation	15,00	-	25,00	-	-	-



Incremento por accesorios / Rough price increase of accessories		€					
Ref. AM	Pintura especial ambiente marino / Special marine environment paint	90,00					
Ref. 3390	Protector de sobretensión / Surge protector	19,00					
Ref. 6033	Raco adaptador de 60 mm. a 33 mm. / Reducing adapter from 60mm. to 33mm.	38,00					
Ref. 6048	Raco adaptador de 60 mm. a 48 mm. / Reducing adapter from 60mm. to 48mm.	41,00					
Ref. 6076	Raco adaptador de 60 mm. a 76 mm. / Reducing adapter from 60mm. to 76mm.	43,00					

OPCIONES / OPTIONS

Incremento por óptica / Rough price increase of optics		29,4w	45,5w	61,6w	100w	150w	200w
Ref. 3408	Óptica simétrica 80° / Symmetric optics 80°	3,20	4,80	4,90	5,00	5,10	5,20
Ref. 3407	Óptica asimétrica 150° / Asymmetric optics 150°	38,90	38,90	38,90	55,60	89,50	122,60
Ref. 3407 3408	Óptica asimétrica 80° / Asymmetric optics 80°	38,90	38,90	38,90	55,60	89,50	122,60
Ref. 3405	Óptica asimétrica Street / Asymmetric optics Street	78,10	78,10	78,10	105,60	149,90	198,60

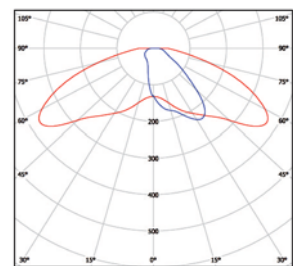

Ref. 3405 Óptica asimétrica Street
Asymmetric optical Street

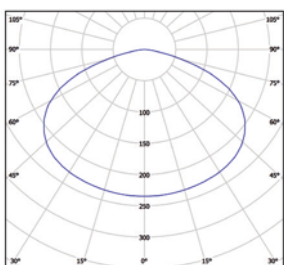

Óptica simétrica de 150°
Symmetric optical 150°

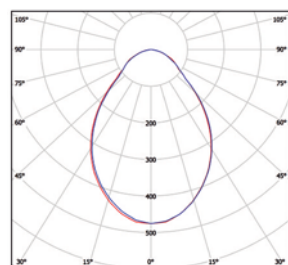

Ref. 3408 Óptica simétrica de 80°
Symmetric optical 80°

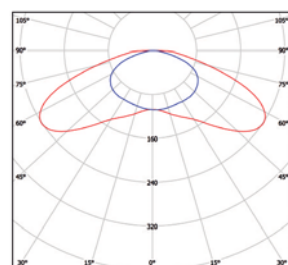

Ref. 3407 Óptica asimétrica de 150°
Asymmetric optical 150°

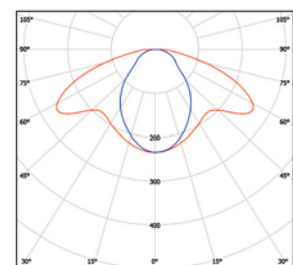

Ref. 3408 3407 Óptica asimétrica de 80°
Asymmetric optical 80°

DURAL LED

Grado de protección **IP65** / Índice de protección antivandálico **IK08**

Material: Cuerpo fabricado en aluminio inyectado, granallado y con recubrimiento de pintura al horno de poliéster sin TGIC resistencia para exterior. Inclinación 10°. Opcionalmente se suministra con pintura especial con resistencia para ambiente marino.

Óptica: Ópticas de 80°/150° incluidas en las lámparas LED. Disponibles varias ópticas asimétricas Ledil (Finlandia). Cierre en metacrilato (PMMA) para LED de gran paso de luz y resistencia UV.

Alimentación: Driver incluido en todos los modelos, factor de potencia >0,95. Puede suministrarse opcionalmente con driver 1-10V, Dali, driver regulable programable 5 niveles sin línea de mando, doble nivel sin línea de mando, regulación en cabecera, regulación con sensor de movimiento.

Lámparas: Módulo compuesto por LED Osram Oslon SSL con una potencia 29,4w, 45,4w, 61,6w 90w y 130w. Disponible en 3000°K, 4000°K o 5700°K.

Protecciones: Sobretensiones estándar del driver 4KV, bajo pedido sobretensiones 10KV.

Vida útil: L70B10 60.000horas

Instalación: Dural vertical con acoplamiento para montaje sobre columnas de Ø76mm de diámetro y con posibilidad de suministrar con adaptador reductor para columnas de Ø60mm. Dural horizontal con acoplamiento sobre báculo Ø60mm.
Un conector eléctrico rápido de 3 o 5 polos, IP66, permite instalar la luminaria sin necesidad de abrirla.

Temp. Ambiente: -20°C a 40°C.

Colores: Gris sablé similar RAL 7012. Disponible en otros colores RAL bajo pedido..

Dural vertical - 28 LED - Óptica simétrica 150° Dural vertical - 28 LED - Symmetric optics 150°



Incluye driver y 28 LED / Includes driver and 28 LED

Ref.	Color / Colour	Lamp	W	mA	Lum.	€	RAEE lum.
3342 91 29 85	Gris Sablé / Sable Gray	LED	29,4w	350	4479	473,10	0,60
3342 91 45 85	Gris Sablé / Sable Gray	LED	45,4w	530	5823	499,90	0,60
3342 91 61 85	Gris Sablé / Sable Gray	LED	61,6w	700	7839	532,10	0,60
3342 91 90 85	Gris Sablé / Sable Gray	LED	90,0w	1000	9406	579,20	0,60
3342 91 13 85	Gris Sablé / Sable Gray	LED	130,0w	700	15678	638,20	0,60

Dural vertical - 28 LED - Óptica simétrica 80° Dural vertical - 28 LED - Symmetric optics 80°



Incluye driver y 28 LED / Includes driver and 28 LED

Ref.	Color / Colour	Lamp	W	mA	Lum.	€	RAEE lum.
3354 91 29 85	Gris Sablé / Sable Gray	LED	29,4w	350	4479	475,20	0,60
3354 91 45 85	Gris Sablé / Sable Gray	LED	45,4w	530	5823	502,60	0,60
3354 91 61 85	Gris Sablé / Sable Gray	LED	61,6w	700	7839	534,40	0,60
3354 91 90 85	Gris Sablé / Sable Gray	LED	90,0w	1000	9406	582,50	0,60
3354 91 13 85	Gris Sablé / Sable Gray	LED	130,0w	700	15678	640,60	0,60

Dural vertical - 28 LED - Óptica asimétrica Dural vertical - 28 LED - Asymmetric optics



Incluye driver y 28 LED / Includes driver and 28 LED

Ref.	Color / Colour	Lamp	W	mA	Lum.	€	RAEE lum.
3362 91 29 85	Gris Sablé / Sable Gray	LED	29,4w	350	4479	565,27	0,60
3362 91 45 85	Gris Sablé / Sable Gray	LED	45,4w	530	5823	599,40	0,60
3362 91 61 85	Gris y Sablé / Sable Gray	LED	61,6w	700	7839	622,20	0,60
3362 91 90 85	Gris y Sablé / Sable Gray	LED	90,0w	1000	9406	671,60	0,60

* Se suministra de manera estándar con lámpara 5700°K.
* Standardly supplied with 5700°K.

DURAL LED

Protection degree **IP65** / Impact protection index **IK08**

Material: Body made of injected aluminum, blasting and polyester thermo painted without TGIC. Outdoor resistance. Optionally it can be supplied with special paint resistant to marine environment.

Optics: 80° / 150° optics included in LED lamps. Available several asymmetric optics LEDIL brand (Finland). Closure in methacrylate (PMMA) for good light path LEDS and UV resistance.

Supply: Driver included for all models, power factor > 0.95. It can be provided optionally with 1-10V dimmable driver, Dali dimmable driver, programmable dimmable driver with 5 levels without control line, double power level with no line of command, header regulation, regulation with motion sensor.

Lamps: Osram LEDs module composed by Oslon SSL with a total power of 29,4w, 45,4w, 61,6w 90w y 130w. Available in 3000°K, 4000°K or 5700°K.

Protection: Standard Surge protector of 4KV driver. Available 10KV surge on request.

Lifespan: L70B10 60.000 hours.

Installation: Vertical Dural with coupling to mount on Ø76 mm diameter posts and with the possibility of being supplied with racor for Ø 60mm diameter posts. Horizontal Dural with coupling to mount on Ø 60mm diameter posts.
A quick connector of 3 or 5 poles, IP66, it allows the installation without opening the luminaire.

Ambient temp: -20° C to 40° C.

Colours: Sablé gray colour similar to RAL 7012. Available in other RAL colours on request

Dural horizontal - 28 LED - Óptica simétrica 150° Dural horizontal - 28 LED - Symmetric optics 150°



Incluye driver y 28 LED / Includes driver and 28 LED

Ref.	Color / Colour	Lamp	W	mA	Lum.	€	RAEE lum.
3343 91 29 85	Gris Sablé / Sable Gray	LED	29,4w	350	4479	510,80	0,60
3343 91 45 85	Gris Sablé / Sable Gray	LED	45,5w	530	5823	536,90	0,60
3343 91 61 85	Gris Sablé / Sable Gray	LED	61,6w	700	7839	564,10	0,60
3343 91 90 85	Gris Sablé / Sable Gray	LED	90,0w	1000	9406	611,20	0,60
3343 91 13 85	Gris Sablé / Sable Gray	LED	130,0w	700	15678	670,20	0,60

Dural horizontal - 28 LED - Óptica simétrica 80° Dural horizontal - 28 LED - Symmetric optics 80°



Incluye driver y 28 LED / Includes driver and 28 LED

Ref.	Color / Colour	Lamp	W	mA	Lum.	€	RAEE lum.
3355 91 29 85	Gris Sablé / Sable Gray	LED	29,4w	350	4479	512,60	0,60
3355 91 45 85	Gris Sablé / Sable Gray	LED	45,4w	530	5823	538,90	0,60
3355 91 61 85	Gris Sablé / Sable Gray	LED	61,6w	700	7839	571,40	0,60
3355 91 90 85	Gris Sablé / Sable Gray	LED	90,0w	1000	9406	619,20	0,60
3355 91 13 85	Gris Sablé / Sable Gray	LED	130,0w	700	15678	677,90	0,60

Dural horizontal - 28 LED - Óptica asimétrica Dural horizontal - 28 LED - Asymmetric optics



Incluye driver y 28 LED / Includes driver and 28 LED

Ref.	Color / Colour	Lamp	W	mA	Lum.	€	RAEE lum.
3363 91 29 85	Gris Sablé / Sable Gray	LED	29,4w	350	4479	599,27	0,60
3363 91 45 85	Gris Sablé / Sable Gray	LED	45,4w	530	5823	631,40	0,60
3363 91 61 85	Gris Sablé / Sable Gray	LED	61,6w	700	7839	654,20	0,60
3363 91 90 85	Gris Sablé / Sable Gray	LED	90,0w	1000	9406	703,60	0,60

* Se suministra de manera estándar con lámpara 5700°K.
* Standardly supplied with 5700°K.

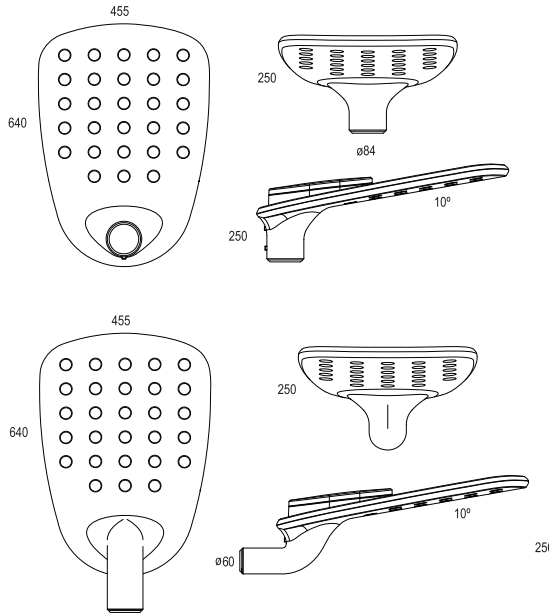

Dural vertical



Dural horizontal



E1



Vertical
A / W = 480 mm.
L / L = 650 mm.
Al / H = 220 mm.



Horizontal
A / W = 480 mm.
L / L = 800 mm.
Al / H = 220 mm.



Cabeza portaequipos con driver para LED adecuado a la potencia de cada modelo y disponible con regulación. Head containing LED driver suitable for the power of each model. Available with regulation.



Ref. 3388 Adaptador reductor para columna de Ø60mm. Reducing adapter for posts Ø60mm.



Óptica asimétrica
Asymmetric optics



Placa PCB Dural de FR4 con 28 LED Osilon SSL de OSRAM
Printed Circuit Board "Dural" with 28 Osilon SSL LED from OSRAM

OPCIONES LED / LED OPTIONS	Ref. 83	Ref. 84	Ref. 85
CRI>70 / Temperatura de color / Colour temperature	3000°K	4000°K	5700°K
Osram Osilon SSL	•	•	•

ACCESORIOS / ACCESSORIES

Incremento por accesorios / Rough price increase of accessories	€				
Ref. 3386 Adaptador reductor para columna de Ø33mm / Reducing adapter for posts Ø33mm					17,60
Ref. 3387 Adaptador reductor para columna de Ø48mm / Reducing adapter for posts Ø48mm					17,70
Ref. 3388 Adaptador reductor para columna de Ø60mm / Reducing adapter for posts Ø60mm					17,80
Ref. 3389 Adaptador reductor para columna de Ø78mm / Reducing adapter for posts Ø78mm					20,40
Ref. 3390 Protector de sobretensión / Surge protector					19,00
Ref. AM Pintura especial ambiente marino / Special marine environment paint					90,00

Incremento respecto al driver / Rough price increase of accessories	29,4w	45,5w	61,6w	90w	130w
Ref. DR Driver regulable 1 - 10v / Dimmable driver 1 - 10v	19,90	19,90	105,00	90,00	95,00
Ref. DRD Driver regulable Dali / Dimmable driver Dali	90,00	30,00	30,00	55,00	55,00
Ref. DRP Driver programable / Programmable driver	71,30	94,80	94,80	94,80	94,80
Ref. DRPNTC Driver prog. y sonda T ^o NTC / Prog. driver & NTC control	87,10	110,60	110,60	110,60	110,60
Ref. DN Regulación doble nivel / Double level dimmable	40,00	42,00	160,00	-	-
Ref. DRC Regulación en cabecera / Regulation at the head	71,30	94,80	94,80	94,80	94,80
Ref. DMR8 Regulación de movimiento / Motion detector	75,00	75,00	170,00	150,00	150,00
Ref. 4160 Driver para funcionam. a 12Vdc. / Driver for 12Vdc operation	15,00	-	25,00	-	-

Nº LEDs	W	mA	Lúmenes / Lumens		
			3000°K	4000°K	5700°K
28	29,4w	350	3047	4116	4479
28	45,4w	530	4115	5544	5823
28	61,6w	700	5180	7000	7839
28	90w	1000	6216	8400	9406
28	130w	700	10360	14000	15678
28	150w	500	10567	14280	16000

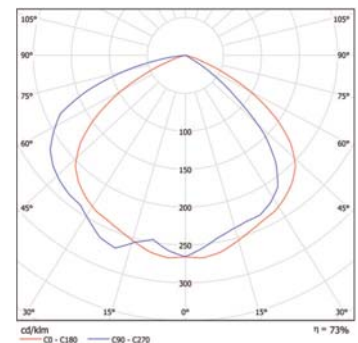

Ref. 3342 Dural con óptica simétrica 150°
FHS: 0,14%
Dural 150° symmetric optics

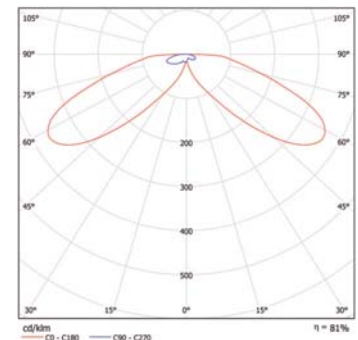

Ref. 3362 Dural con óptica asimétrica
FHS: 0,58%
Dural asymmetric optics

PROTEK Q2 CITY LED

Grado de protección **IP65** / Índice de protección antivandálico **IK08**

Material:	Cuerpo fabricado en aluminio inyectado, granallado y con recubrimiento de pintura al horno de poliéster sin TGIC resistencia para exterior. Opcionalmente se suministra con pintura especial con resistencia para ambiente marino.
Óptica:	Ópticas de 80°/150° incluidas en las lámparas LED. Disponibles varias ópticas asimétricas Ledil (Finlandia). Cierre en metacrilato (PMMA) para LED de gran paso de luz y resistencia UV.
Alimentación:	Driver incluido en todos los modelos, factor de potencia >0,95. Puede suministrarse opcionalmente con driver 1-10V, Dali, driver regulable programable 5 niveles sin línea de mando, doble nivel sin línea de mando, regulación en cabecera, regulación con sensor de movimiento.
Lámparas:	Módulo compuesto por LED Osram Oslon SSL con una potencia 60w, 100w, 150w y 200w. Disponible en 3000°K, 4000°K o 5700°K. PCB en aluminio de alta pureza 1,6mm con conectores rápidos.
Protecciones:	Protección interna con diodo individual para cada LED. Sobretensiones estándar del driver 4KV, bajo pedido sobretensiones 10KV.
Vida útil:	L70B10 60.000horas
Instalación:	Sobre columna o báculo, luminaria ajustable en orientación. Ø 60mm. (Otras dimensiones bajo pedido) Un conector eléctrico rápido de 3 o 5 polos, IP66, permite instalar la luminaria sin necesidad de abrirla.
Temp. ambiente:	-20°C a 40°C. Se puede solicitar opcionalmente con sonda de temperatura NTC.
Colores:	Color gris similar RAL 9022, blanco similar RAL XXXX o negro similar RAL XXXX. Disponible en otros colores RAL bajo pedido.

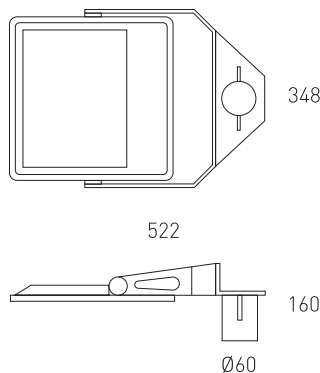

Protek Q2 City LED vertical - Óptica simétrica de 150°
Protek Q2 City LED vertical - Symmetric optical 150°



Incluye driver y lámparas LEDs
Includes LED lamps and driver

Ref.	Color / Colour	Lamp.	Lumens	W	€	RAEE lum.
4320 01 60 85	Blanco / White	LED	6272	60w	528,10	0,60
4320 02 60 85	Negro / Black	LED	6272	60w	530,10	0,60
4320 58 60 85	Gris / Gray	LED	6272	60w	530,10	0,60
4320 01 10 85	Blanco / White	LED	9632	100w	572,80	0,60
4320 02 10 85	Negro / Black	LED	9632	100w	574,20	0,60
4320 58 10 85	Gris / Gray	LED	9632	100w	574,20	0,60
4320 01 15 85	Blanco / White	LED	14336	150w	756,10	0,60
4320 02 15 85	Negro / Black	LED	14336	150w	758,40	0,60
4320 58 15 85	Gris / Gray	LED	14336	150w	758,40	0,60
4320 01 20 85	Blanco / White	LED	19264	200w	899,90	0,60
4320 02 20 85	Negro / Black	LED	19264	200w	903,40	0,60
4320 58 20 85	Gris / Gray	LED	19264	200w	903,40	0,60

* Se suministra de manera estándar con lámpara 5700° K.
* Standardly supplied with 5700° K lamp.

PROTEK Q2 CITY LED

Protection degree **IP65** / Impact protection index **IK08**

Material:	Body made of injected aluminum, blasting and polyester thermo painted without TGIC. Outdoor resistance. Optionally it can be supplied with special paint resistant to marine environment.
Optics:	80° / 150° optics included in LED lamps. Available several asymmetric optics LEDIL brand (Finland). Closure in methacrylate (PMMA) for good light path LEDs and UV resistance.
Supply:	Driver included for all models, power factor > 0.95. It can be provided optionally with 1-10V dimmable driver, Dali dimmable driver, programmable dimmable driver with 5 levels without control line, double power level with no line of command, header regulation, regulation with motion sensor.
Lamps:	Osram LEDs module composed by Oslon SSL with a total power of 60w, 100w, 150w, and 200w. Available in 3000°K, 4000°K or 5700°K. High purity aluminium PCB from 1,6 mm. with quick connectors.
Protections:	Internal protection with individual diode for each LED. Standard Surge protector of 4KV driver. Available 10KV surge on request.
Life span:	L70B10 60.000 hours.
Installation:	To mount on column or crossier. Luminaire adjustable in several orientation degrees. Ø 60mm. (Other dimensions on request). A quick connector of 3 or 5 poles, IP66, it allows the installation without opening the luminaire.
Ambient temp:	-20° C to 40° C. Optionally supplied with NTC temperature probe.
Colours:	Gray colour similar to RAL 9022, white colour similar to RAL XXXX, and black colour similar to RAL XXXX. Available in other RAL colours on request.



Protek Q2 City LED vertical - Óptica simétrica de 80°
Protek Q2 City LED vertical - Symmetric optical 80°



Incluye driver y lámparas LEDs
Includes LED lamps and driver

Ref.	Color / Colour	Lamp.	Lumens	W	€	RAEE lum.
4321 01 60 85	Blanco / White	LED	6272	60w	530,10	0,60
4321 02 60 85	Negro / Black	LED	6272	60w	533,20	0,60
4321 58 60 85	Gris / Gray	LED	6272	60w	533,20	0,60
4321 01 10 85	Blanco / White	LED	9632	100w	575,40	0,60
4321 02 10 85	Negro / Black	LED	9632	100w	577,80	0,60
4321 58 10 85	Gris / Gray	LED	9632	100w	577,80	0,60
4321 01 15 85	Blanco / White	LED	14336	150w	758,40	0,60
4321 02 15 85	Negro / Black	LED	14336	150w	759,20	0,60
4321 58 15 85	Gris / Gray	LED	14336	150w	759,20	0,60
4321 01 20 85	Blanco / White	LED	19264	200w	903,80	0,60
4321 02 20 85	Negro / Black	LED	19264	200w	905,50	0,60
4321 58 20 85	Gris / Gray	LED	19264	200w	905,50	0,60

* Se suministra de manera estándar con lámpara 5000° K.
* Standardly supplied with 5000° K lamp.

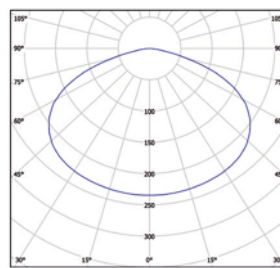
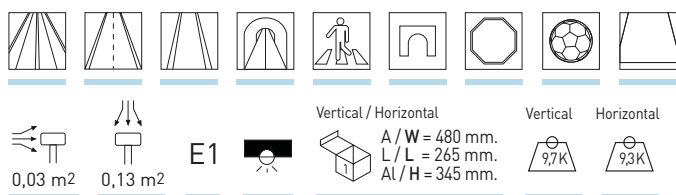
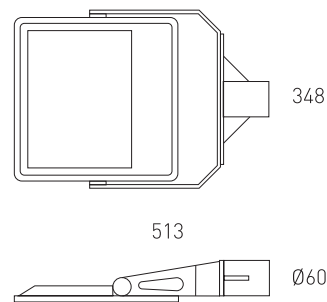

Óptica simétrica de 150°
Symmetric optical 150°

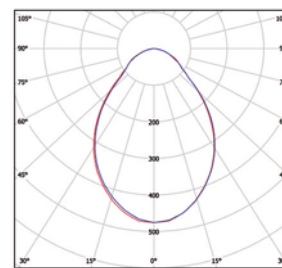

Óptica simétrica de 80°
Symmetric optical 80°

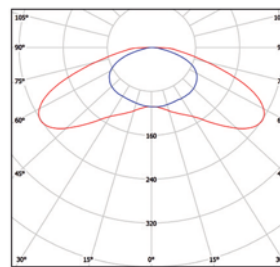

Ref. 3407 Óptica asimétrica de 150°
Asymmetric optical 150°

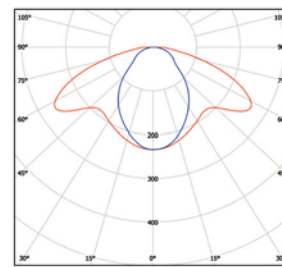

Ref. 3407 Óptica asimétrica de 80°
Asymmetric optical 80°

Protek Q2 City LED horizontal - Óptica simétrica de 150°
Protek Q2 City LED horizontal - Symmetric optical 150°



Incluye driver y lámparas LEDs
Includes LED lamps and driver

Ref.	Color / Colour	Lamp.	Lumens	W	€	RAEE lum.
4322 01 60 85	Blanco / White	LED	6272	60w	597,10	0,60
4322 02 60 85	Negro / Black	LED	6272	60w	599,90	0,60
4322 58 60 85	Gris / Gray	LED	6272	60w	599,90	0,60
4322 01 10 85	Blanco / White	LED	9632	100w	570,20	0,60
4322 02 10 85	Negro / Black	LED	9632	100w	572,90	0,60
4322 58 10 85	Gris / Gray	LED	9632	100w	572,90	0,60
4322 01 15 85	Blanco / White	LED	14336	150w	745,20	0,60
4322 02 15 85	Negro / Black	LED	14336	150w	756,80	0,60
4322 58 15 85	Gris / Gray	LED	14336	150w	756,80	0,60
4322 01 20 85	Blanco / White	LED	19264	200w	899,20	0,60
4322 02 20 85	Negro / Black	LED	19264	200w	902,40	0,60
4322 58 20 85	Gris / Gray	LED	19264	200w	902,40	0,60

* Se suministra de manera estándar con lámpara 5700° K.
* Standardly supplied with 5700° K lamp.

Protek Q2 City LED horizontal - Óptica simétrica de 80°
Protek Q2 City LED horizontal - Symmetric optical 80°



Incluye driver y lámparas LEDs
Includes LED lamps and driver

Ref.	Color / Colour	Lamp.	Lumens	W	€	RAEE lum.
4323 01 60 85	Blanco / White	LED	6272	60w	599,90	0,60
4323 02 60 85	Negro / Black	LED	6272	60w	604,10	0,60
4323 58 60 85	Gris / Gray	LED	6272	60w	604,10	0,60
4323 01 10 85	Blanco / White	LED	9632	100w	574,60	0,60
4323 02 10 85	Negro / Black	LED	9632	100w	576,20	0,60
4323 58 10 85	Gris / Gray	LED	9632	100w	576,20	0,60
4323 01 15 85	Blanco / White	LED	14336	150w	756,40	0,60
4323 02 15 85	Negro / Black	LED	14336	150w	758,60	0,60
4323 58 15 85	Gris / Gray	LED	14336	150w	758,60	0,60
4323 01 20 85	Blanco / White	LED	19264	200w	902,10	0,60
4323 02 20 85	Negro / Black	LED	19264	200w	904,50	0,60
4323 58 20 85	Gris / Gray	LED	19264	200w	904,50	0,60

* Se suministra de manera estándar con lámpara 5000° K.
* Standardly supplied with 5000° K lamp.

OPCIONES LED / OPTIONS LED

Ref. 83	Ref. 84	Ref. 85		
CRI>80 / Temp. de color / Colour temperature	3000°K	4000°K	5000°K	
Lúmenes / Lumens Osram Oslon SSL	60w	100w	150w	200w
	5340	8202	12207	16404
	5740	8815	13120	17630
	6272	9632	14336	19264

Incremento respecto al driver (por unidad) / Rough price increase of driver (per unit)

Ref.	60w	100w	150w	200w
Ref. DR Driver reg. 1 - 10v / Dimmable driver 1 - 10v	105,00	90,00	95,00	225,00
Ref. DRD Driver regulable Dali / Dimmable driver Dali	30,00	55,00	55,00	40,00
Ref. DRP Driver programable / Programmable driver	94,80	94,80	94,80	-
Ref. DRPNTC Driver p. y sonda Tª NTC / P. driver & NTC control	110,60	110,60	110,60	-
Ref. DMR8 Regulación de movimiento / Motion detector	170,00	150,00	150,00	-
Ref. DRC Regulación en cabecera / Regulation at the head	94,80	94,80	94,80	-

Incremento por accesorios / Rough price increase of accessories

Ref.	60w	100w	150w	200w
Ref. 3407 LEDs óptica asim. / LEDs with asymmetrical optics	39,90	55,60	93,50	117,30
Ref. 3409 LEDs ópt. sim. 48° / LEDs with symmetric optics 48°	72,24	72,24	112,60	140,00
Ref. 3390 Protector de sobretensión / Surge protector	19,00	19,00	19,00	-

Incremento por accesorios / Rough price increase of accessories

Ref.	€
Ref. AM Pintura especial ambiente marino / Special marine environment paint	90,00

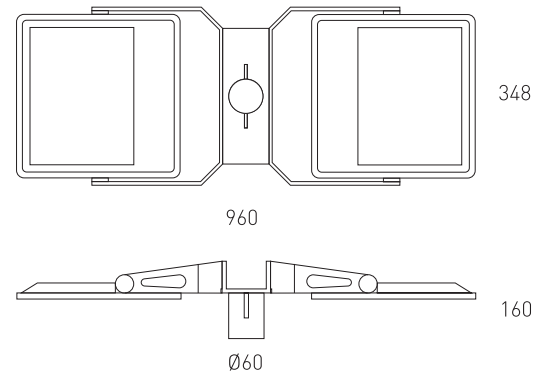
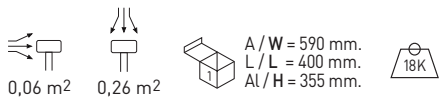

Protek Q2 City LED Dúo - Óptica simétrica de 150°
Protek Q2 City LED Duo - Symmetric optical 150°



Incluye driver y lámparas LEDs
Includes LED lamps and driver

Ref.	Color / Colour	Lamp.	Lumens	W	€	RAEE lum.
4324 01 60 85	Blanco / White	LED	12544	2x60w	1022,60	0,60
4324 02 60 85	Negro / Black	LED	12544	2x60w	1027,80	0,60
4324 58 60 85	Gris / Gray	LED	12544	2x60w	1027,80	0,60
4324 01 10 85	Blanco / White	LED	19264	2x100w	1112,20	0,60
4324 02 10 85	Negro / Black	LED	19264	2x100w	1114,40	0,60
4324 58 10 85	Gris / Gray	LED	19264	2x100w	1114,40	0,60
4324 01 15 85	Blanco / White	LED	28672	2x150w	1480,60	0,60
4324 02 15 85	Negro / Black	LED	28672	2x150w	1484,20	0,60
4324 58 15 85	Gris / Gray	LED	28672	2x150w	1484,20	0,60
4324 01 20 85	Blanco / White	LED	38528	2x200w	1778,40	0,60
4324 02 20 85	Negro / Black	LED	38528	2x200w	1779,60	0,60
4324 58 20 85	Gris / Gray	LED	38528	2x200w	1779,60	0,60

* Se suministra de manera estándar con lámpara 5700° K.
* Standardly supplied with 5700° K lamp.

Protek Q2 City LED Dúo - Óptica simétrica de 80°
Protek Q2 City LED Duo - Symmetric optical 80°



Incluye driver y lámparas LEDs
Includes LED lamps and driver

Ref.	Color / Colour	Lamp.	Lumens	W	€	RAEE lum.
4325 01 60 85	Blanco / White	LED	12544	2x60w	1027,90	0,60
4325 02 60 85	Negro / Black	LED	12544	2x60w	1033,20	0,60
4325 58 60 85	Gris / Gray	LED	12544	2x60w	1033,20	0,60
4325 01 10 85	Blanco / White	LED	19264	2x100w	1117,40	0,60
4325 02 10 85	Negro / Black	LED	19264	2x100w	1118,30	0,60
4325 58 10 85	Gris / Gray	LED	19264	2x100w	1118,30	0,60
4325 01 15 85	Blanco / White	LED	28672	2x150w	1485,20	0,60
4325 02 15 85	Negro / Black	LED	28672	2x150w	1488,80	0,60
4325 58 15 85	Gris / Gray	LED	28672	2x150w	1488,80	0,60
4325 01 20 85	Blanco / White	LED	38528	2x200w	1782,60	0,60
4325 02 20 85	Negro / Black	LED	38528	2x200w	1783,80	0,60
4325 58 20 85	Gris / Gray	LED	38528	2x200w	1783,80	0,60

* Se suministra de manera estándar con lámpara 5000° K.
* Standardly supplied with 5000° K lamp.

Incremento por accesorios / Rough price increase of accessories		€
Ref. AM	Pintura especial ambiente marino / Special marine environment paint	120,00

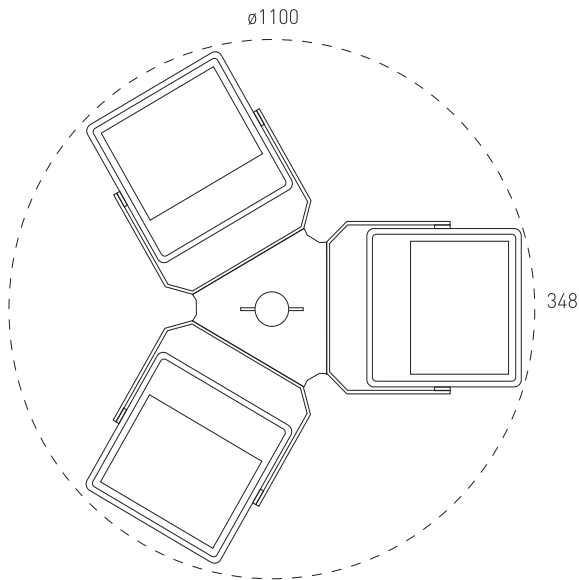
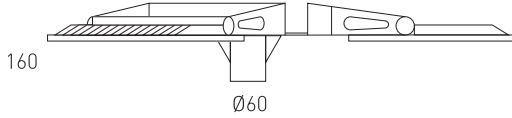

Protek Q2 City LED Trio - Óptica simétrica de 150°
Protek Q2 City LED Trio - Symmetric optical 150°



Incluye driver y lámparas LEDs
Includes LED lamps and driver

Ref.	Color / Colour	Lamp.	Lumens	W	€	RAEE lum.
4326 01 60 85	Blanco / White	LED	18816	3x60w	1518,20	0,60
4326 02 60 85	Negro / Black	LED	18816	3x60w	1526,10	0,60
4326 58 60 85	Gris / Gray	LED	18816	3x60w	1526,10	0,60
4326 01 10 85	Blanco / White	LED	28896	3x100w	1652,60	0,60
4326 02 10 85	Negro / Black	LED	28896	3x100w	1656,10	0,60
4326 58 10 85	Gris / Gray	LED	28896	3x100w	1656,10	0,60
4326 01 15 85	Blanco / White	LED	43008	3x150w	2207,20	0,60
4326 02 15 85	Negro / Black	LED	43008	3x150w	2209,60	0,60
4326 58 15 85	Gris / Gray	LED	43008	3x150w	2209,60	0,60
4326 01 20 85	Blanco / White	LED	57792	3x200w	2654,40	0,60
4326 02 20 85	Negro / Black	LED	57792	3x200w	2658,10	0,60
4326 58 20 85	Gris / Gray	LED	57792	3x200w	2658,10	0,60

* Se suministra de manera estándar con lámpara 5700° K.
* Standardly supplied with 5700° K lamp.

Protek Q2 City LED Trio - Óptica simétrica de 80°
Protek Q2 City LED Trio - Symmetric optical 80°



Incluye driver y lámparas LEDs
Includes LED lamps and driver

Ref.	Color / Colour	Lamp.	Lumens	W	€	RAEE lum.
4327 01 60 85	Blanco / White	LED	18816	3x60w	1529,90	0,60
4327 02 60 85	Negro / Black	LED	18816	3x60w	1534,10	0,60
4327 58 60 85	Gris / Gray	LED	18816	3x60w	1534,10	0,60
4327 01 10 85	Blanco / White	LED	28896	3x100w	1660,40	0,60
4327 02 10 85	Negro / Black	LED	28896	3x100w	1663,00	0,60
4327 58 10 85	Gris / Gray	LED	28896	3x100w	1663,00	0,60
4327 01 15 85	Blanco / White	LED	43008	3x150w	2214,10	0,60
4327 02 15 85	Negro / Black	LED	43008	3x150w	2216,50	0,60
4327 58 15 85	Gris / Gray	LED	43008	3x150w	2216,50	0,60
4327 01 20 85	Blanco / White	LED	57792	3x200w	2660,70	0,60
4327 02 20 85	Negro / Black	LED	57792	3x200w	2664,40	0,60
4327 58 20 85	Gris / Gray	LED	57792	3x200w	2664,40	0,60

* Se suministra de manera estándar con lámpara 5000° K.
* Standardly supplied with 5000° K lamp.

Incremento por accesorios / Rough price increase of accessories	€
Ref. AM Pintura especial ambiente marino / Special marine environment paint	150,00





KONAK CITY LED

Grado de protección IP65 / Índice de protección antivandálico IK08

Material:	Cuerpo fabricado en aluminio inyectado, granallado y con recubrimiento de pintura al horno de poliéster sin TGIC resistencia para exterior. Opcionalmente se suministra con pintura especial con resistencia para ambiente marino.
Óptica:	Ópticas de 80°/150° incluidas en las lámparas LED. Disponibles varias ópticas asimétricas Ledil (Finlandia). Cierre en metacrilato (PMMA) para LED de gran paso de luz y resistencia UV.
Alimentación:	Driver incluido en todos los modelos, factor de potencia >0,95. Puede suministrarse opcionalmente con driver 1-10V, Dali, driver regulable programable 5 niveles sin línea de mando, doble nivel sin línea de mando, regulación en cabecera, regulación con sensor de movimiento.
Lámparas:	Módulo compuesto por LED Osram Oslon SSL con una potencia 40w, 100w, 150w, 200w Y 250w. Disponible en 3000°K, 4000°K o 5700°K. PCB en aluminio de alta pureza lacado en blanco 1,6mm con conectores rápidos.
Protecciones:	Protección interna con diodo individual para cada LED. Sobretensiones estándar del driver 4KV.
Vida útil:	L70B10 60.000 horas. Sobre columna o báculo, luminaria ajustable en orientación. Ø 60mm. (Otras dimensiones bajo pedido).
Instalación:	Un conector eléctrico rápido de 3 o 5 polos, IP66, permite instalar la luminaria sin necesidad de abrirla.
Temp. ambiente:	-20°C a 40°C. Se puede solicitar opcionalmente con sonda de temperatura NTC.
Colores:	Gris sablé similar RAL 7012. Disponible en otros colores RAL bajo pedido.

KONAK CITY LED

Protection degree IP65 / Impact protection index IK08

Material:	Body made of injected aluminum, blasting and polyester thermo painted without TGIC. Outdoor resistance. Optionally it can be supplied with special paint resistant to marine environment.
Optics:	80° / 150° optics included in LED lamps. Available several asymmetric optics LEDIL brand (Finland). Closure in methacrylate (PMMA) for good light path LEDs and UV resistance.
Supply:	Driver included for all models, power factor > 0.95. It can be provided optionally with 1-10V dimmable driver, Dali dimmable driver, programmable dimmable driver with 5 levels without control line, double power level with no line of command, header regulation, regulation with motion sensor.
Lamps:	Osram LEDs module composed by Oslon SSL with a total power of 40w, 100w, 150w, 200w Y 250w. Available in 3000°K, 4000°K or 5700°K. High purity aluminium PCB from 1,6 mm. lacquered in white colour with quick connectors.
Protections:	Internal protection with individual diode for each LED. Standard Surge protector of 4KV driver.
Lifespan:	L70B10 60.000 hours.
Installation:	To mount on column or crosier. Luminaire adjustable in several orientation degrees. Ø 60mm. (Other dimensions on request). A quick connector of 3 or 5 poles, IP66, it allows the installation without opening the luminaire.
Ambient temp.:	-20° C to 40° C. Optionally supplied with NTC temperature probe.
Colours:	Sablé gray colour similar to RAL 7012. Available in other RAL colours on request.



Konak city LED vertical - Óptica simétrica 150°
Konak city LED vertical - Symmetric optics 150°



Incluye driver y lámparas LEDs / Includes driver and LEDs lamp

Ref.	Color / Colour	Lumens	W	€	RAEE lum.
4170 58 40 85	Gris / Gray	4032	40w	564,20	0,60
4170 58 10 85	Gris / Gray	9632	100w	617,10	0,60
4170 58 15 85	Gris / Gray	14336	150w	799,30	0,60
4170 58 20 85	Gris / Gray	19264	200w	915,40	0,60
4170 58 25 85	Gris / Gray	23520	250w	1180,40	0,60

* Se suministra de manera estándar con LED 5700°K.

* Standardly supplied with 5700°K LED lamp.

Konak city LED vertical - Óptica simétrica 80°
Konak city LED vertical whit LED symmetric optics 80°



Incluye driver y lámparas LEDs / Includes driver and LEDs lamp

Ref.	Color / Colour	Lumens	W	€	RAEE lum.
4172 58 40 85	Gris / Gray	4032	40w	567,70	0,60
4172 58 10 85	Gris / Gray	9632	100w	619,50	0,60
4172 58 15 85	Gris / Gray	14336	150w	801,20	0,60
4172 58 20 85	Gris / Gray	19264	200w	917,80	0,60
4172 58 25 85	Gris / Gray	23520	250w	1182,30	0,60

* Se suministra de manera estándar con LED 5000°K.

* Standardly supplied with 5000°K LED lamp.

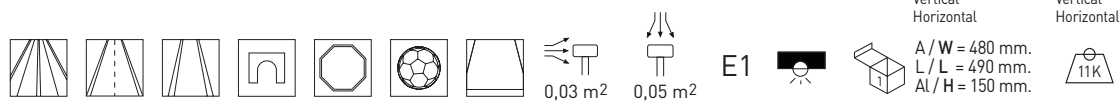
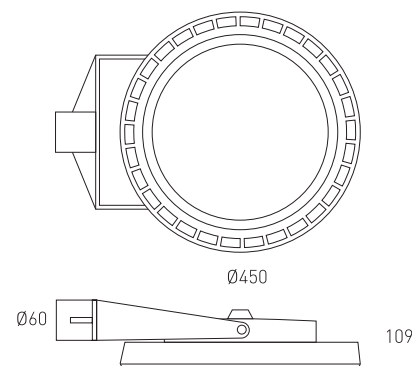

Incremento respecto al driver / Rough price increase of accessories		40w	100w	150w	200w	250w
Ref. DR	Driver regulable 1 - 10v / Dimmable driver 1 - 10v	19,90	90,00	95,00	225,00	150,00
Ref. DRD	Driver regulable Dali / Dimmable driver Dali	115,00	55,00	55,00	40,00	150,00
Ref. DRP	Driver programable / Programmable driver	71,30	94,80	94,80	225,00	150,00
Ref. DRPNTC	Driver prog. y sonda Tª NTC / Prog. driver & NTC control	87,10	110,60	110,60	240,80	165,80
Ref. DRC	Regulación en cabecera / Regulation at the head	71,30	94,80	94,80	225,00	150,00
Ref. 3409	Leds con óptica simétrica 48° / LEDs with symmetric optics 48°	32,40	72,24	-	140,00	-
Ref. 3407	Leds con óptica asimétrica / LEDs with asymmetrical optics	28,50	67,50	93,50	117,30	146,10

Incremento por accesorios / Rough price increase of accessories		€
Ref. AM	Pintura especial ambiente marino / Special marine environment paint	90,00

Konak city LED horizontal - Óptica simétrica 150°
Konak city LED horizontal - Symmetric optics 150°



Incluye driver y lámparas LEDs / Includes driver and LEDs lamp

Ref.	Color / Colour	Lumens	W	€	RAEE lum.
4171 58 40 85	Gris / Gray	4032	40w	566,80	0,60
4171 58 10 85	Gris / Gray	9632	100w	618,20	0,60
4171 58 15 85	Gris / Gray	14336	150w	800,90	0,60
4171 58 20 85	Gris / Gray	19264	200w	916,60	0,60
4171 58 25 85	Gris / Gray	23520	250w	1181,40	0,60

* Se suministra de manera estándar con LED 5700°K.
* Standardly supplied with 5700°K LED lamp.

Konak city LED horizontal - Óptica simétrica 80°
Konak city LED horizontal - Symmetric optics 80°



Incluye driver y lámparas LEDs / Includes driver and LEDs lamp

Ref.	Color / Colour	Lumens	W	€	RAEE lum.
4173 58 40 85	Gris / Gray	4032	40w	570,30	0,60
4173 58 10 85	Gris / Gray	9632	100w	620,30	0,60
4173 58 15 85	Gris / Gray	14336	150w	802,20	0,60
4173 58 20 85	Gris / Gray	19264	200w	918,90	0,60
4173 58 25 85	Gris / Gray	23520	250w	1183,90	0,60

* Se suministra de manera estándar con LED 5000°K.
* Standardly supplied with 5000°K LED lamp.

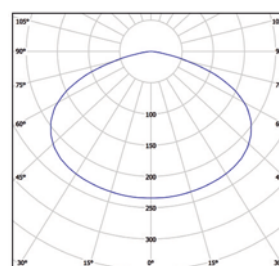

Óptica simétrica de 150°
Symmetric optical 150°

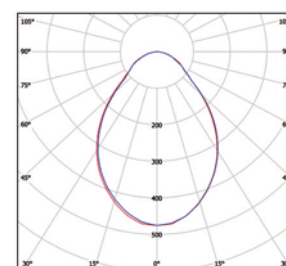

Óptica simétrica de 80°
Symmetric optical 80°

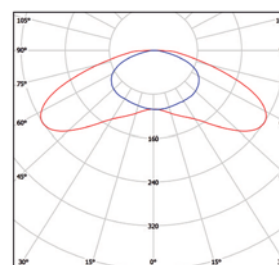

Ref. 3407 Óptica asimétrica de 150°
Asymmetric optical 150°

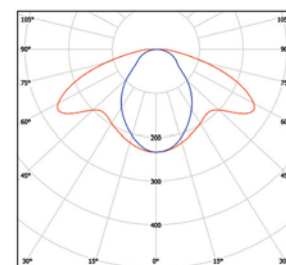

Ref. 3407 Óptica asimétrica de 80°
Asymmetric optical 80°

OPCIONES LED / OPTIONS LED

CRI>80 / Temp. de color / Colour temperature	W	Ref. 83 3000°K	Ref. 84 4000°K	Ref. 85 5000°K
Lúmenes / Lumens Osram Oslon SSL	40w	3433	3690	4032
	100w	8202	8815	9632
	150w	12207	13120	14336
	200w	16404	17630	19264
	250w	20028	21525	23520

ECODUT LED

Grado de protección IP65 / Índice de protección antivandálico IK08

Material:	Cuerpo fabricado en aluminio inyectado, granallado y con recubrimiento de pintura al horno de poliéster sin TGIC resistencia para exterior. Opcionalmente se suministra con pintura especial con resistencia para ambiente marino.
Óptica:	Ópticas de 80°/150° incluidas en las lámparas LED. Disponibles varias ópticas asimétricas Ledil (Finlandia). Cierre vidrio securizado.
Alimentación:	Driver incluido en todos los modelos, factor de potencia >0,95. Puede suministrarse opcionalmente con driver 1-10V, Dali, driver regulable programable 5 niveles sin línea de mando, doble nivel sin línea de mando, regulación en cabecera, regulación con sensor de movimiento.
Lámparas:	Módulo compuesto por LED Osram Oscon SSL con una potencia 29,4w, 42w, 45,4w 61,6w, 88w. Disponible en 3000°K, 4000°K o 5700°K. PCB en aluminio de alta pureza lacado en blanco 1,6mm con conectores rápidos.
Protecciones:	Protección interna con diodo individual para cada LED. Sobretensiones estándar del driver 4KV, bajo pedido sobretensiones 10KV.
Vida útil:	L70B10 60.000horas
Instalación:	Sobre columna o báculo. Ø 60mm. (Otras dimensiones bajo pedido) Un conector eléctrico rápido de 3 o 5 polos, IP66, permite instalar la luminaria sin necesidad de abrirla.
Temp. ambiente:	-20°C a 40°C. Se puede solicitar opcionalmente con sonda de temperatura NTC.
Colores:	Gris sablé similar RAL 7012. Disponible en otros colores RAL bajo pedido.

ECODUT LED

Protection degree IP65 / Impact protection index IK08

Material:	Body made of injected aluminum, blasting and polyester thermo painted without TGIC. Outdoor resistance. Optionally it can be supplied with special paint resistant to marine environment.
Optics:	80° / 150° optics included in LED lamps. Available several asymmetric optics LEDIL brand (Finland). Closure in safety glass.
Supply:	Driver included for all models, power factor > 0.95. It can be provided optionally with 1-10V dimmable driver, Dali dimmable driver, programmable dimmable driver with 5 levels without control line, double power level with no line of command, header regulation, regulation with motion sensor.
Lamps:	Osram LEDs module composed by Oscon SSL with a total power of 29,4w, 42w, 45,4w, 61,6w, y 88w. Available in 3000°K, 4000°K or 5700°K. High purity aluminium PCB from 1,6 mm. lacquered in white colour with quick connectors.
Protections:	Internal protection with individual diode for each LED. Standard Surge protector of 4KV driver. Available 10KV surge on request.
Lifespan:	L70B10 60.000 hours.
Installation:	To mount on column or crossier. Luminaire adjustable in several orientation degrees. Ø 60mm. (Other dimensions on request). A quick connector of 3 or 5 poles, IP66, it allows the installation without opening the luminaire.
Ambient temp.:	-20° C to 40° C. Optionally supplied with NTC temperature probe
Colours:	Sablé gray colour similar to RAL 7012. Available in other RAL colours on request.



Ecodut 28 LED - Óptica simétrica 150°
Ecodut 28 LED - Symmetric optics 150°



Incluye driver y 28 LED / Includes driver and 28 LED

Ref.	Color / Colour	Lamp	W	mA	Lum.	€	RAEE lum.
3353 58 29 85	Gris / Gray	LED	29,4w	350	4479	462,65	0,60
3353 58 45 85	Gris / Gray	LED	45,4w	530	5823	498,75	0,60
3353 58 61 85	Gris / Gray	LED	61,6w	700	7839	515,85	0,60

* Se suministra de manera estándar con lámpara 5700°K.
* Standardly supplied with 5700°K.

Ecodut 40 LED - Óptica simétrica 150°
Ecodut 40 LED - Symmetric optics 150°



Incluye driver y 40 LED / Includes driver and 40 LED

Ref.	Color / Colour	Lamp	W	mA	Lum.	€	RAEE lum.
3353 58 42 85	Gris / Gray	LED	42w	350	6400	570,20	0,60
3353 58 88 85	Gris / Gray	LED	88w	700	11200	623,20	0,60

* Se suministra de manera estándar con lámpara 5700°K
* Standardly supplied with 5700°K.

OPCIONES LED / LED OPTIONS

	Ref. 83	Ref. 84	Ref. 85
CRI>80 / Temperatura de color / Colour temperature	3000°K	4000°K	5700°K
Osram Oscon SSL	•	•	•

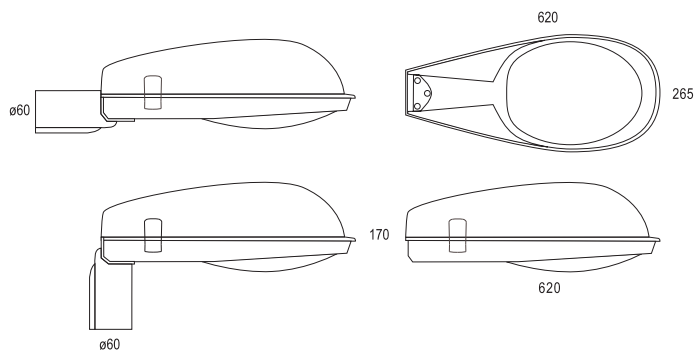

Se suministra con accesorio para columna en ángulo 90° o 180°
 Supplied with accessories for columns of 90 ° and 180 °

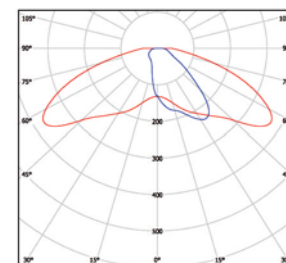
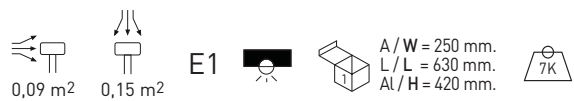

Ref. 3405 Óptica asimétrica Street
 Asymmetric optical Street

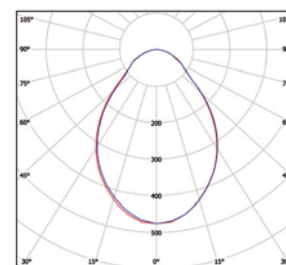

Ref. 3408 Óptica simétrica de 80°
 Symmetric optical 80°

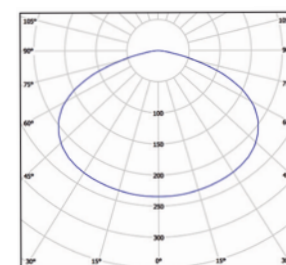

Óptica simétrica de 150°
 Symmetric optical 150°

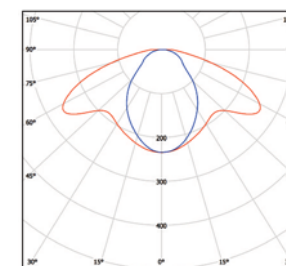

Ref. 3408 3407 Óptica asimétrica de 80°
 Asymmetric optical 80°

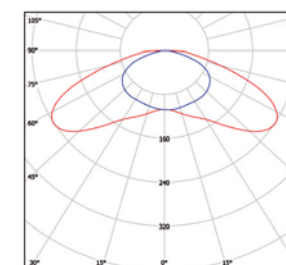

Ref. 3407 Óptica asimétrica de 150°
 Asymmetric optical 150°

Incremento respecto al driver / Rough price increase of accessories		29,4w	42w	45,4w	61,6w	88w
Ref. DR	Driver regulable 1 - 10v / Dimmable driver 1 - 10v	19,90	19,90	19,90	105,00	90,00
Ref. DRD	Driver regulable Dali / Dimmable driver Dali	90,00	115,00	30,00	30,00	55,00
Ref. DRP	Driver programable / Programmable driver	71,30	94,80	94,80	94,80	94,80
Ref. DRPNTC	Driver prog. y sonda T ³ NTC / Prog. driver & NTC control	87,10	110,60	110,60	110,60	116,60
Ref. DRC	Regulación en cabecera / Regulation at the head	71,30	94,80	94,80	94,80	94,80
Ref. DN	Regulación doble nivel / Double level dimmable	40,00	42,00	42,00	160,00	130,00
Ref. DMR8	Regulación de movimiento / Motion detector	75,00	75,00	75,00	170,00	150,00
Ref. 4160	Driver para funcionam. a 12Vdc. / Driver for 12Vdc operation	15,00	15,00	-	25,00	15,00

OPCIONES / OPTIONS

Incremento por óptica / Rough price increase of optics		29,4w	42w	45,4w	61,6w	88w
Ref. 3408	Óptica simétrica 80° / Symmetric optics 80°	3,20	4,80	3,20	3,20	4,80
Ref. 3407	Óptica asimétrica 150° / Asymmetric optics 150°	36,12	55,60	36,12	36,12	55,60
Ref. 3407 3408	Óptica asimétrica 80° / Asymmetric optics 80°	36,12	55,60	36,12	36,12	55,60
Ref. 3405	Óptica asimétrica Street / Asymmetric optics Street	78,10	99,80	78,10	78,10	99,80

ACCESORIOS / ACCESSORIES

Incremento por accesorios / Rough price increase of accessories		€
Ref. 3390	Protector de sobretensión / Surge protector	19,00
Ref. 6033	Raco adaptador de 60 mm. a 33 mm. / Reducing adapter from 60mm. to 33mm.	38,00
Ref. 6048	Raco adaptador de 60 mm. a 48 mm. / Reducing adapter from 60mm. to 48mm.	41,00
Ref. 6076	Raco adaptador de 60 mm. a 76 mm. / Reducing adapter from 60mm. to 76mm.	43,00

Nº LEDs	W	mA	Lúmenes / Lumens		
			3000°K	4000°K	5700°K
28	29,4w	350	3047	4116	4479
28	45,4w	530	4115	5544	5823
28	61,6w	700	5180	7000	7839
40	42w	350	4360	5880	6400
40	88w	700	7400	10000	11200

ECODUT

Grado de protección **IP65** / Índice de protección antivandálico **IK08**

Material:	Cuerpo de la luminaria en aluminio inyectado con recubrimiento de pintura al horno.
Óptica:	Reflector de aluminio para lámparas en posición horizontal con cristal protector hermético y securizado.
Alimentación:	Todos los modelos incluyen equipos y lámparas adecuados.
Lámparas:	Lámparas de sodio de alta presión, sodio blanco y halogenuro metálico.
Instalación:	Acoplamiento para montaje sobre columnas en posición horizontal, vertical. ø60mm.
Colores:	Gris. Disponible en otros colores RAL bajo pedido.

ECODUT

Protection degree **IP65** / Impact protection index **IK08**

Material:	Body of the luminaire made in thermo painted injected aluminium.
Optics:	Aluminium reflector for lamps in horizontal position with sealed protector glass.
Supply:	All models include control gear and lamps.
Lamps:	High pressure sodium lamps, white sodium lamps, and metallic halide lamps.
Installation:	Coupling for mounting in columns in horizontal or vertical. ø60mm.
Colours:	Grey. It can be supplied in other RAL colours by request.



ECODUT - LUMINARIA VACÍA / EMPTY LAMP

€

Ref. 3346 58	Luminaria vacía con cierre de cristal securizado y reflector IP65 Empty lamp with tempered glass closing and IP65 reflector	192,60
---------------------	--	---------------

Ecodut - Sodio de alta presión / High Pressure Sodium



Incluye luminaria, cierres, equipo y lámpara SODIO ALTA PRESIÓN
Includes closing, control gear and lamp HIGH PRESSURE SODIUM

Ref.	Color / Colour	Lamp	Port./ L/H	W	€	lum. ^{RAEE}	lamp
3347 58 50	Gris / Gray	SON-T	E-27	50W	300,32	0,70	0,30
3347 58 70	Gris / Gray	SON-T	E-27	70W	301,03	0,70	0,30
3347 58 10	Gris / Gray	SON-T	E-40	100W	302,58	0,70	0,30
3347 58 15	Gris / Gray	SON-T	E-40	150W	315,42	0,70	0,30
3347 58 25	Gris / Gray	SON-T	E-40	250W	329,84	0,70	0,30

Ecodut - Halogenuro metálico / Metal halide



Incluye luminaria, cierres, equipo y lámpara HQI
Includes closing, control gear and HQI lamp

RAEE

Ref.	Color / Colour	Lamp	Port./ L/H	W	€	lum.	lamp
3350 58 50	Gris / Gray	CDO TT	E-27	50W	348,28	0,70	0,30
3350 58 70	Gris / Gray	CDO TT	E-27	70W	352,69	0,70	0,30
3350 58 10	Gris / Gray	CDO TT	E-40	100W	356,58	0,70	0,30
3350 58 15	Gris / Gray	CDO TT	E-40	150W	360,88	0,70	0,30
3350 58 25	Gris / Gray	CDO TT	E-40	250W	436,38	0,70	0,30

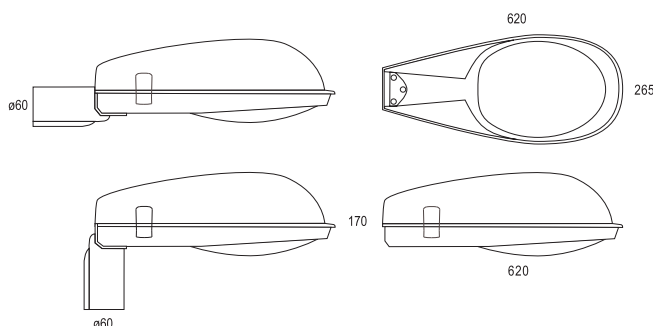

Se suministra con accesorio para columna en ángulo 90° o 180°
 Supplied with accessories for columns of 90 ° and 180 °

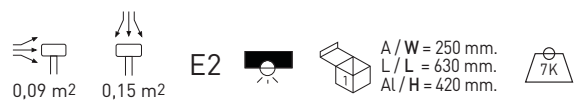

OPCIONES DE REGULACIÓN DOBLE NIVEL CON LÍNEA DE MANDO
 DOUBLE LEVEL DIMMABLE WITH ADDITIONAL CONTROL WIRE OPTION

Incremento respecto a la luminaria NO regulable / Rough price increase of control gear	€
Ref. RLM70 Sodio alta presión / HQI 70W / High pressure sodium / HQI 70w	56,00
Ref. RLM100 Sodio alta presión / HQI 100W / High pressure sodium / HQI 100w	58,20
Ref. RLM150 Sodio alta presión / HQI 150W / High pressure sodium / HQI 150w	72,20
Ref. RLM250 Sodio alta presión / HQI 250W / High pressure sodium / HQI 250w	85,40

OPCIONES DE REGULACIÓN DOBLE NIVEL SIN LÍNEA DE MANDO
 DOUBLE LEVEL DIMMABLE WITHOUT ADDITIONAL CONTROL WIRE OPTION

Incremento respecto a la luminaria NO regulable / Rough price increase of control gear	€
Ref. RSL50 Sodio alta presión / HQI 50W / High pressure sodium / HQI 50w	56,10
Ref. RSL70 Sodio alta presión / HQI 70W / High pressure sodium / HQI 70w	57,10
Ref. RSL100 Sodio alta presión / HQI 100W / High pressure sodium / HQI 100w	58,30
Ref. RSL150 Sodio alta presión / HQI 150W / High pressure sodium / HQI 150w	72,90
Ref. RSL250 Sodio alta presión / HQI 250W / High pressure sodium / HQI 250w	92,20

- ▶ ILUMINACIÓN RESIDENCIAL
- ▶ RESIDENTIAL LIGHTING

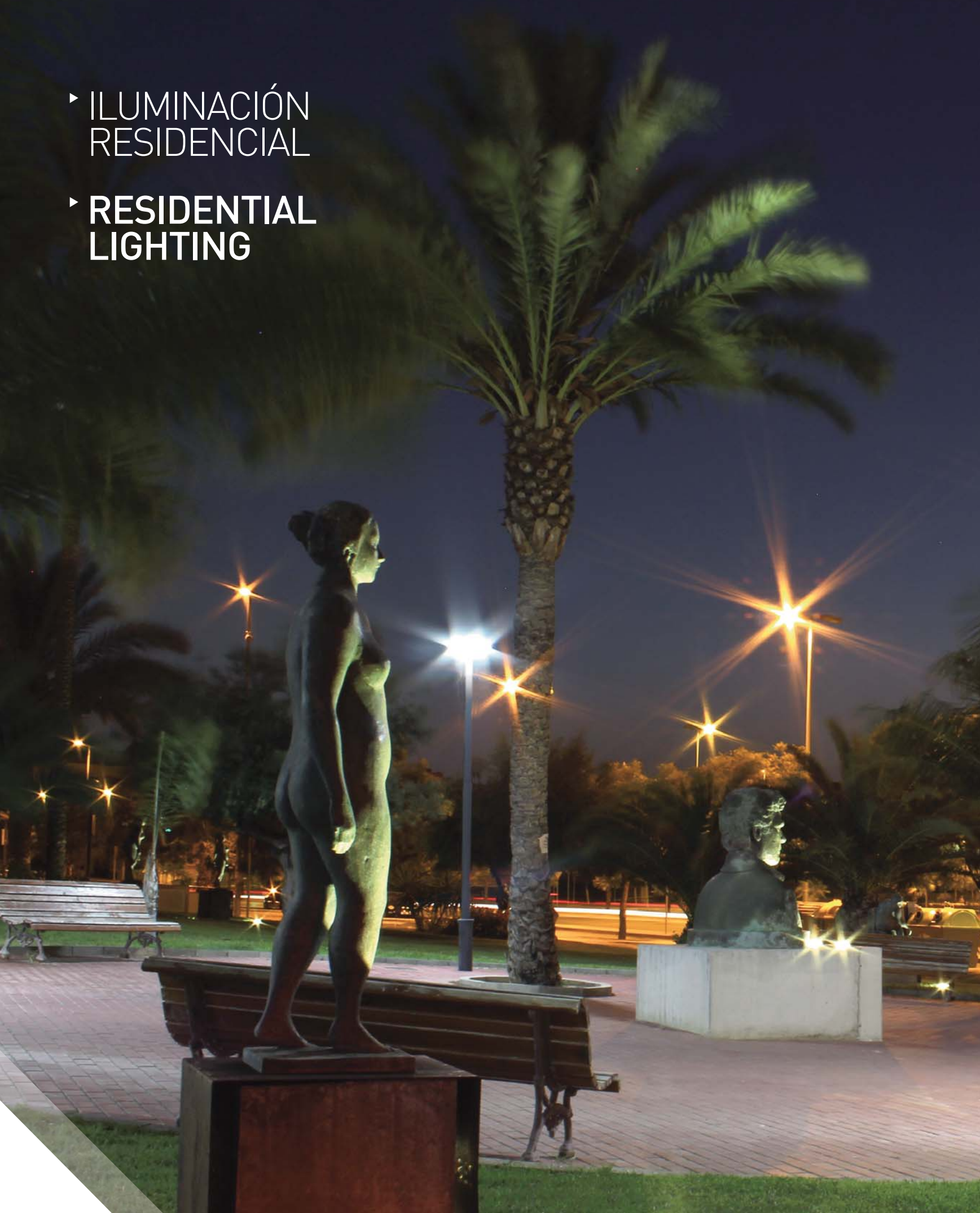



AURIS LED

Grado de protección IP65 / Índice de protección antivandálico IK08

- Material:** Cuerpo fabricado en aluminio inyectado, granallado y con recubrimiento de pintura al horno de poliéster sin TGIC resistencia para exterior. Opcionalmente se suministra con pintura especial con resistencia para ambiente marino.
- Óptica:** Difusor opal policarbonato con protección UV que proporciona una iluminación homogénea en toda la superficie.
- Alimentación:** Driver incluido en todos los modelos, factor de potencia >0,95. Puede suministrarse opcionalmente con driver 1-10V, Dali, driver regulable programable 5 niveles sin línea de mando, doble nivel sin línea de mando, regulación en cabecera.
- Lámparas:** Módulo compuesto por LED Osram Duris E5 con una potencia 30w, 40w y 60w. Disponible en 3000°K, 4000°K o 5700°K.
- Protecciones:** Sobretensiones estándar del driver 4KV, bajo pedido sobretensiones 10KV.
- Vida útil:** L70B10 60.000 horas.
- Instalación:** Sobre columna. Ø 60mm. (Otras dimensiones bajo pedido). Un conector eléctrico rápido de 3 o 5 polos, IP66, permite instalar la luminaria sin necesidad de abrirla.
- Temp. ambiente:** -20°C a 40°C. Se puede solicitar opcionalmente con sonda de temperatura NTC.
- Colores:** Gris sablé similar RAL 7012. Disponible en otros colores RAL bajo pedido.

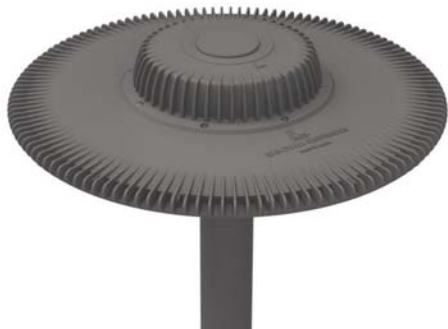

Auriss LED

Incluye driver y lámparas LED / Includes driver and LED lamps

Ref.	Color / Colour	Lumens	W	€	RAEE lum.
4190 58 30 85	Gris / Gray	3000	30w	492,80	0,10
4190 58 40 85	Gris / Gray	4000	40w	510,80	0,10
4190 58 60 85	Gris / Gray	6000	60w	658,50	0,10

* Se suministra de manera estándar con LED 5700°K.

* Standardly supplied with 5700°K LED lamp.

OPCIONES / OPTIONS LED	Ref. 83	Ref. 84	Ref. 85
CRI>80 / Temperatura de color / Colour temperature	3000°K	4000°K	5700°K
Lum 30w	2850	3000	3000
Lum 40w	3800	4000	4000
Lum 60w	5700	6000	6000

ACCESORIOS / ACCESSORIES

Incremento por accesorios / Rough price increase of accessories	€
Ref. 3390 Protector de sobretensión / Surge protector	19,00
Ref. AM Pintura especial ambiente marino / Special marine environment paint	90,00
Ref. 6033 Raco adaptador de 60 mm. a 33 mm. / Reducing adapter from 60mm. to 33mm.	38,00
Ref. 6048 Raco adaptador de 60 mm. a 48 mm. / Reducing adapter from 60mm. to 48mm.	41,00
Ref. 6076 Raco adaptador de 60 mm. a 76 mm. / Reducing adapter from 60mm. to 76mm.	43,00

AURIS LED

Protection degree IP65 / Impact protection index IK08

- Material:** Body made of injected aluminum, blasting and polyester thermo painted without TGIC. Outdoor resistance. Optionally it can be supplied with special paint resistant to marine environment.
- Optics:** Opal polycarbonate diffuser that provides UV protection uniform illumination over the entire surface.
- Supply:** Driver included for all models, power factor > 0.95. It can be provided optionally with 1-10V dimmable driver, Dali dimmable driver, programmable dimmable driver with 5 levels without control line, double power level with no line of command, header regulation, regulation with motion sensor.
- Lamps:** Osram LEDs module composed by Duris E5 with a total power of 30w, 40w and 60w. Available in 3000°K, 4000°K or 5700°K.
- Protection:** Standard Surge protector of 4KV driver. Available 10KV surge on request.
- Lifespan:** L70B10 60.000 hours.
- Installation:** To mount on post of Ø 60mm. (Other dimensions on request). A quick connector of 3 or 5 poles, IP66, it allows the installation without opening the luminaire.
- Ambient temp.:** -20° C to 40° C. Optionally supplied with NTC temperature probe.
- Colours:** Sablé gray colour similar to RAL 7012. Available in other RAL colours on request.

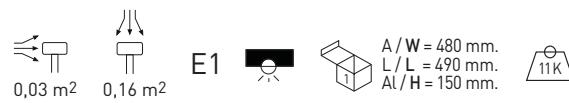
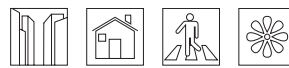

Incremento respecto al driver (por unidad) / Rough price increase of driver (per unit)

		30w	40w	60w
Ref. DR	Driver reg. 1 - 10v / Dimmable driver 1 - 10v	19,90	19,90	105,00
Ref. DRD	Driver regulable Dali / Dimmable driver Dali	90,00	90,00	30,00
Ref. DRP	Driver programable / Programmable driver	71,30	71,30	-
Ref. DRPNTC	Driver prog. y sonda Tª NTC / Prog. driver & NTC control	87,10	87,10	-
Ref. DN	Regulación doble nivel / Double level dimmable	40,00	40,00	160,00

AURIS LED SUSPENSIÓN

Grado de protección IP65 / Índice de protección antivandálico IK08

- Material:** Cuerpo fabricado en aluminio inyectado, granallado y con recubrimiento de pintura al horno de poliéster sin TGIC resistencia para exterior. Opcionalmente se suministra con pintura especial con resistencia para ambiente marino.
- Óptica:** Difusor opal policarbonato con protección UV que proporciona una iluminación homogénea en toda la superficie.
- Alimentación:** Driver incluido en todos los modelos, factor de potencia >0,95. Puede suministrarse opcionalmente con driver 1-10V, Dali, driver regulable programable 5 niveles sin línea de mando, doble nivel sin línea de mando, regulación en cabecera, regulación con sensor de movimiento.
- Lámparas:** Módulo compuesto por LED Osram Duris E5 con una potencia 30w, 40w y 60w. Disponible en 3000°K, 4000°K o 5700°K.
- Protecciones:** Sobretensiones estándar del driver 4KV, bajo pedido sobretensiones 10KV.
- Vida útil:** L70B10 60.000 horas.
- Instalación:** Sobre columna. Ø 60mm. (Otras dimensiones bajo pedido). Un conector eléctrico rápido de 3 o 5 polos, IP66, permite instalar la luminaria sin necesidad de abrirla.
- Temp. ambiente:** -20°C a 40°C.
- Colores:** Gris sablé similar RAL 7012. Disponible en otros colores RAL bajo pedido.

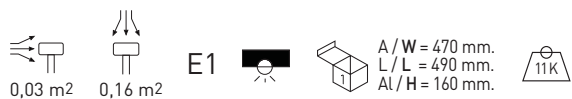

A / W = 470 mm.
L / L = 490 mm.
AL / H = 160 mm.



Auris LED suspensión / suspension

Incluye driver y lámparas LED / Includes driver and LED lamps

Ref.	Color / Colour	Lumens	W	€	RAEE lum.
4191 58 30 85	Gris / Gray	3000	30w	493,40	0,10
4191 58 40 85	Gris / Gray	4000	40w	511,20	0,10
4191 58 60 85	Gris / Gray	6000	60w	658,90	0,10

* Se suministra de manera estándar con LED 5700°K.

* Standardly supplied with 5700°K LED lamp.

ACCESORIOS / ACCESSORIES

Incremento por accesorios / Rough price increase of accessories		€
Ref. 3390	Protector de sobretensión / Surge protector	19,00
Ref. AM	Pintura especial ambiente marino / Special marine environment paint	90,00

AURIS LED SUSPENSION

Protection degree IP65 / Impact protection index IK08

- Material:** Body made of injected aluminum, blasting and polyester thermo painted without TGIC. Outdoor resistance. Optionally it can be supplied with special paint resistant to marine environment.
- Optics:** Opal polycarbonate diffuser that provides UV protection uniform illumination over the entire surface.
- Supply:** Driver included for all models, power factor > 0.95. It can be provided optionally with 1-10V dimmable driver, Dali dimmable driver, programmable dimmable driver with 5 levels without control line, double power level with no line of command, header regulation, regulation with motion sensor.
- Lamps:** Osram LEDs module composed by Duris E5 with a total power of 30w, 40w and 60w. Available in 3000°K, 4000°K or 5700°K.
- Protections:** Standard Surge protector of 4KV driver. Available 10KV surge on request.
- Lifespan:** L70B10 60.000 hours.
- Installation:** To mount on post of Ø 60mm. (Other dimensions on request). A quick connector of 3 or 5 poles, IP66, it allows the installation without opening the luminaire.
- Ambient temp.:** -20° C to 40° C.
- Colours:** Sablé gray colour similar to RAL 7012. Available in other RAL colours on request.



OPCIONES / OPTIONS LED	Ref. 83	Ref. 84	Ref. 85
CRI>80 / Temperatura de color / Colour temperature	3000°K	4000°K	5700°K
Lum 30w	2850	3000	3000
Lum 40w	3800	4000	4000
Lum 60w	5700	6000	6000

Incremento respecto al driver (por unidad) / Rough price increase of driver (per unit)

		30w	40w	60w
Ref. DR	Driver reg. 1 - 10v / Dimmable driver 1 - 10v	19,90	19,90	105,00
Ref. DRD	Driver regulable Dali / Dimmable driver Dali	90,00	90,00	30,00
Ref. DRP	Driver programable / Programmable driver	71,30	71,30	94,80
Ref. DRPNTC	Driver prog. y sonda T° NTC / Prog. driver & NTC control	87,10	87,10	-
Ref. DN	Regulación doble nivel / Double level dimmable	40,00	40,00	-
Ref. DMR8	Regulación de movimiento / Motion detector	75,00	75,00	170,00

KLOSS CITY LED

Grado de protección IP65 / Índice de protección antivandálico IK09

Material:	Cuerpo en policarbonato y herrajes fabricados en chapa de acero con recubrimiento de pintura al horno de poliéster sin TGIC resistencia para exterior. Opcionalmente se suministra con pintura especial con resistencia para ambiente marino.
Óptica:	Difusor opal policarbonato con protección UV que proporciona una iluminación homogénea en toda la superficie.
Alimentación:	Driver incluido en todos los modelos, factor de potencia >0,95. Puede suministrarse opcionalmente con driver 1-10V, Dali, driver regulable programable 5 niveles sin línea de mando, doble nivel sin línea de mando, regulación en cabecera, regulación con sensor de movimiento.
Lámparas:	Módulo compuesto por LED Osram Duris E5 con una potencia 20w, 42w y 60w. Disponible en 3000°K, 4000°K o 5700°K.
Protecciones:	Sobretensiones estándar del driver 4KV, bajo pedido sobretensiones 10KV.
Vida útil:	L70B10 50.000 horas.
Instalación:	Directamente a pared o columna mediante tornillería (no suministrada) Un conector eléctrico rápido de 3 o 5 polos, IP66, permite instalar la luminaria sin necesidad de abrirla.
Temp. Ambiente:	-20°C a 40°C. Se puede solicitar opcionalmente con sonda de temperatura NTC.
Colores:	Gris sablé similar RAL 7012. Disponible en otros colores RAL bajo pedido.

KLOSS CITY LED

Protection degree IP65 / Impact protection index IK09

Material:	Body made of polycarbonate and fittings made on sheet steel with polyester thermo painted coating without TGIC. Outdoor resistance. Optionally it can be supplied with special paint resistant to marine environment.
Optics:	Opal polycarbonate diffuser that provides UV protection that allows uniform illumination over the entire surface.
Supply:	Driver included for all models, power factor > 0.95. It can be provided optionally with 1-10V dimmable driver, Dali dimmable driver, programmable dimmable driver with 5 levels without control line, double power level with no line of command, header regulation and regulation with motion sensor.
Lamps:	Osram LEDs module composed by Duris E5 with a total power of 20w, 42w, 60w. Available in 3000°K, 4000°K or 5700°K.
Protections:	Standard Surge protector of 4KV driver. Available 10KV surge on request.
Lifespan:	L70B10 50.000 hours.
Installation:	Directly to ceiling or pole through screws (not included). A quick connector of 3 or 5 poles, IP66, it allows the installation without opening the luminaire.
Ambient temp.:	-20° C to 40° C. Optionally supplied with NTC temperature probe.
Colours:	Sablé gray colour similar to RAL 7012. Available in other RAL colours on request.



Kloss City LED

Incluye driver y lámparas LED / Includes driver and LED lamps

Ref.	Color / Colour	Lumens	W	€	RAEE lum.
4165 58 20 85	Gris / Gray	2100	20w	255,40	0,10
4165 58 42 85	Gris / Gray	4200	42w	284,90	0,10
4165 58 60 85	Gris / Gray	6300	60w	308,90	0,10

* Se suministra de manera estándar con LED 5700°K.

* Standardly supplied with 5700°K LED lamp.

OPCIONES / OPTIONS LED	Ref. 83	Ref. 84	Ref. 85
CRI>80 / Temperatura de color / Colour temperature	3000°K	4000°K	5700°K
Lum 20w	1900	2000	2100
Lum 42w	3800	4000	4200
Lum 60w	5700	6000	6300

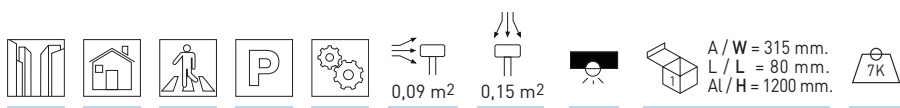
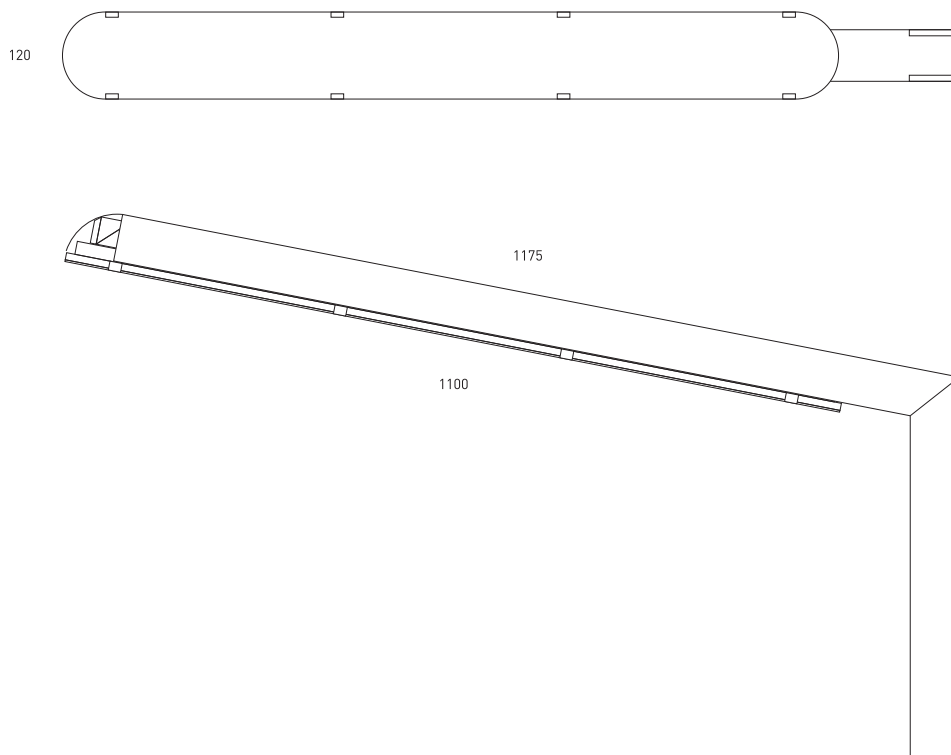

ACCESORIOS / ACCESSORIES

Incremento por accesorios / Rough price increase of accessories		€
Ref. 3390	Protector de sobretensión / Surge protector	19,00
Ref. AM	Pintura especial ambiente marino / Special marine environment paint	70,00

Incremento respecto al driver / Rough price increase of accessories		20/40w	60w
Ref. DR	Driver regulable 1 - 10v / Dimmable driver 1 - 10v	79,20	90,10
Ref. DRD	Driver regulable Dali / Dimmable driver Dali	79,82	90,80
Ref. DRP	Driver programable / Programmable driver	71,30	-
Ref. DRDNTC	Driver prog. y sonda T ^o NTC / Prog. driver & NTC control	87,10	-

PROTEK CITY LED

Grado de protección **IP65** / Índice de protección antivandálico **IK08**

- Material:** Cuerpo fabricado en aluminio inyectado, granallado y con recubrimiento de pintura al horno de poliéster sin TGIC resistencia para exterior. Opcionalmente se suministra con pintura especial con resistencia para ambiente marino.
- Óptica:** Ópticas incluidas en las lámparas LED. Cierre en metacrilato (PMMA) para LED de gran paso de luz y resistencia UV.
- Alimentación:** Driver incluido en todos los modelos, factor de potencia >0,95. Puede suministrarse opcionalmente con driver 1-10V, Dali, driver regulable programable 5 niveles sin línea de mando, doble nivel sin línea de mando, regulación en cabecera.
- Lámparas:** Módulo compuesto por LED Osram Oslon SSL con una potencia 16w, 25w y 50w. Disponible en 3000°K, 4000°K o 5700°K. PCB en aluminio de alta pureza 1,6mm con conectores rápidos.
- Protecciones:** Sobretensiones estándar del driver 4KV, bajo pedido sobretensiones 10KV.
- Vida útil:** L70B10 50.000 horas.
- Instalación:** Sobre columna o báculo, luminaria ajustable en orientación. Ø 60mm. (Otras dimensiones bajo pedido). Un conector eléctrico rápido de 3 o 5 polos, IP66, permite instalar la luminaria sin necesidad de abrirla.
- Temp. Ambiente:** -20°C a 40°C. Se puede solicitar opcionalmente con sonda de temperatura NTC.
- Colores:** Color gris similar RAL 9022, blanco similar RAL XXXX o negro similar RAL XXXX. Disponible en otros colores RAL bajo pedido.

PROTEK CITY LED

Protection degree **IP65** / Impact protection index **IK08**

- Material:** Body made of injected aluminum, blasting and polyester thermo painted without TGIC. Outdoor resistance. Optionally it can be supplied with special paint resistant to marine environment.
- Optics:** Optics included in LED lamps. Closure in methacrylate (PMMA) for good light path LEDs and UV resistance.
- Supply:** Driver included for all models, power factor > 0.95. It can be provided optionally with 1-10V dimmable driver, Dali dimmable driver, programmable dimmable driver with 5 levels without control line, double power level with no line of command, header regulation.
- Lamps:** Osram LEDs module composed by Oslon SSL with a total power of 16w, 25w and 50w. Available in 3000°K, 4000°K or 5700°K. High purity aluminium PCB from 1,6 mm. with quick connectors.
- Protections:** Standard Surge protector of 4KV driver. Available 10KV surge on request.
- Life span:** L70B10 50.000 hours.
- Installation:** To mount on column or crossier. Luminaire adjustable in several orientation degrees. Ø 60mm. (Other dimensions on request). A quick connector of 3 or 5 poles, IP66, it allows the installation without opening the luminaire.
- Ambient temp.:** -20° C to 40° C. Optionally supplied with NTC temperature probe.
- Colours:** Gray colour similar to RAL 9022, white colour similar to RAL XXXX, and black colour similar to RAL XXXX. Available in other RAL colours on request.

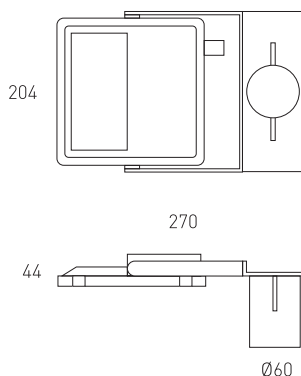

Protek City LED vertical / Protek City LED vertical

Incluye driver y lámparas LEDs
Includes LED lamps and driver

Ref.	Color / Colour	Lamp.	Lumens	W	€	RAEE lum.
4175 01 16 85	Blanco / White	LED	3162	16w	210,10	0,60
4175 02 16 85	Negro / Black	LED	3162	16w	213,30	0,60
4175 58 16 85	Gris / Gray	LED	3162	16w	213,30	0,60
4175 01 25 85	Blanco / White	LED	3162	25w	215,20	0,60
4175 02 25 85	Negro / Black	LED	3162	25w	218,40	0,60
4175 58 25 85	Gris / Gray	LED	3162	25w	218,40	0,60
4175 01 50 85	Blanco / White	LED	6332	50w	254,10	0,60
4175 02 50 85	Negro / Black	LED	6332	50w	256,60	0,60
4175 58 50 85	Gris / Gray	LED	6332	50w	256,60	0,60

* Se suministra de manera estándar con lámpara 5700° K.

* Standardly supplied with 5700° K lamp.

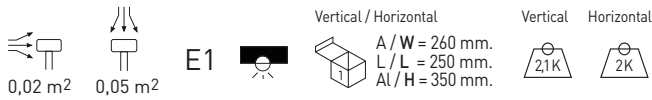
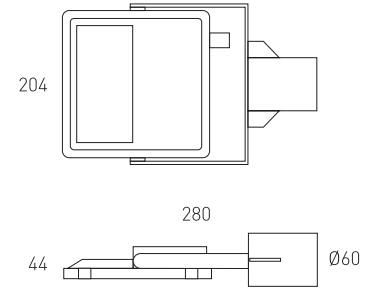

Protek City LED horizontal / Protek City LED horizontal

Incluye driver y lámparas LEDs
Includes LED lamps and driver

Ref.	Color / Colour	Lamp.	Lumens	W	€	RAEE lum.
4176 01 16 85	Blanco / White	LED	2110	16w	212,60	0,60
4176 02 16 85	Negro / Black	LED	2110	16w	216,50	0,60
4176 58 16 85	Gris / Gray	LED	2110	16w	216,50	0,60
4176 01 25 85	Blanco / White	LED	3162	25w	217,80	0,60
4176 02 25 85	Negro / Black	LED	3162	25w	221,00	0,60
4176 58 25 85	Gris / Gray	LED	3162	25w	221,00	0,60
4176 01 50 85	Blanco / White	LED	6332	50w	256,70	0,60
4176 02 50 85	Negro / Black	LED	6332	50w	259,20	0,60
4176 58 50 85	Gris / Gray	LED	6332	50w	259,20	0,60

* Se suministra de manera estándar con lámpara 5700° K.
* Standardly supplied with 5700° K lamp.

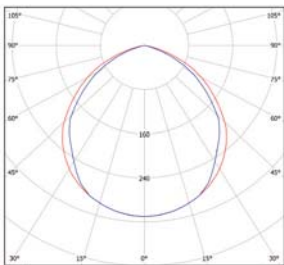

Difusor transparente
Transparent diffuser

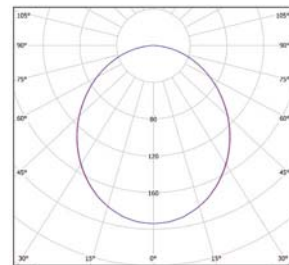

Ref. 4131
Difusor opal
Opal diffuser

OPCIONES / OPTIONS LED	Ref. 83	Ref. 84	Ref. 85
CRI>80 / Temp. de color / Colour temperature	3000°K	4000°K	5700°K
Lúmenes / Lumens Osram Duris E5	16w 1939	2110	2110
	25w 2909	3162	3162
	50w 5818	6332	6332

OPCIONES / OPTIONS

Incremento respecto al driver / Rough price increase of accessories	16w	25w	50w
Ref. DR Driver regulable 1 - 10v / Dimmable driver 1 - 10v	49,90	52,20	64,90
Ref. DN Regulación doble nivel / Double level dimmable	89,90	89,80	89,80
Ref. DRP Driver programable / Programmable driver	71,30	71,30	-
Ref. DRPNTC Driver prog. y sonda Tª NTC / Prog. driver & NTC control	87,10	87,10	-
Ref. 4160 Driver alumbrado 12V / Driver 12V lighting	16,80	16,80	-

Incremento por accesorios / Rough price increase of accessories	€
Ref. 4131 Difusor opal / Opal diffuser	9,90
Ref. AM Pintura especial ambiente marino / Special marine environment paint	60,00

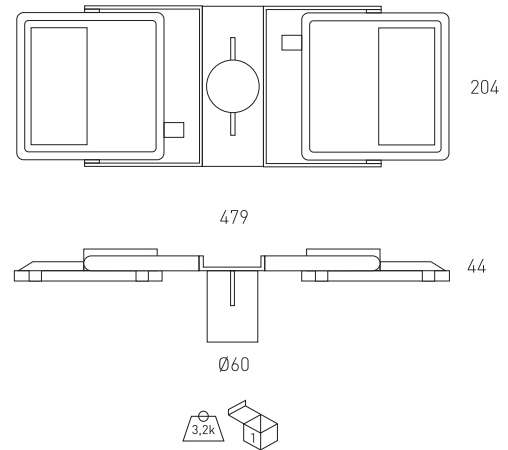
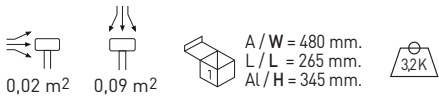

Protek City LED Dúo / Protek City LED Duo



Incluye dos unidades Protek City LED y soporte Dúo.
Includes two Protek City LED and Duo support .

Ref.	Color / Colour	Lamp.	Lumens	W	€	RAEE lum.
4177 01 16 85	Blanco / White	LED	4220	2x16w	388,90	0,60
4177 02 16 85	Negro / Black	LED	4220	2x16w	388,95	0,60
4177 58 16 85	Gris / Gray	LED	4220	2x16w	388,95	0,60
4177 01 25 85	Blanco / White	LED	6324	2x25w	399,80	0,60
4177 02 25 85	Negro / Black	LED	6324	2x25w	399,90	0,60
4177 58 25 85	Gris / Gray	LED	6324	2x25w	399,90	0,60
4177 01 50 85	Blanco / White	LED	12664	2x50w	483,60	0,60
4177 02 50 85	Negro / Black	LED	12664	2x50w	485,70	0,60
4177 58 50 85	Gris / Gray	LED	12664	2x50w	485,70	0,60

* Se suministra de manera estándar con lámpara 5700° K.

* Standardly supplied with 5700° K lamp.

OPCIONES / OPTIONS LED		Ref. 83	Ref. 84	Ref. 85
CRIs-80 / Temp. de color / Colour temperature	W	3000°K	4000°K	5700°K
Lúmenes / Lumens Osram Duris E5	16w	1939	2110	2110
	25w	2909	3162	3162
	50w	5818	6332	6332

OPCIONES / OPTIONS

Incremento respecto al driver / Rough price increase of accessories		16w	25w	50w
Ref. DR	Driver regulable 1 - 10v / Dimmable driver 1 - 10v	49,90	52,20	64,90
Ref. DN	Regulación doble nivel / Double level dimmable	89,90	89,80	89,80
Ref. DRP	Driver programable / Programmable driver	71,30	71,30	-
Ref. DRPNTC	Driver prog. y sonda Tª NTC / Prog. driver & NTC control	87,10	87,10	-
Ref. 4160	Driver alumbrado 12V / Driver 12V lighting	16,80	16,80	-

Incremento por accesorios / Rough price increase of accessories		€
Ref. 4131	Difusor opal (por unidad) / Opal diffuser (per unit)	9,90
Ref. AM	Pintura especial ambiente marino / Special marine environment paint	90,00

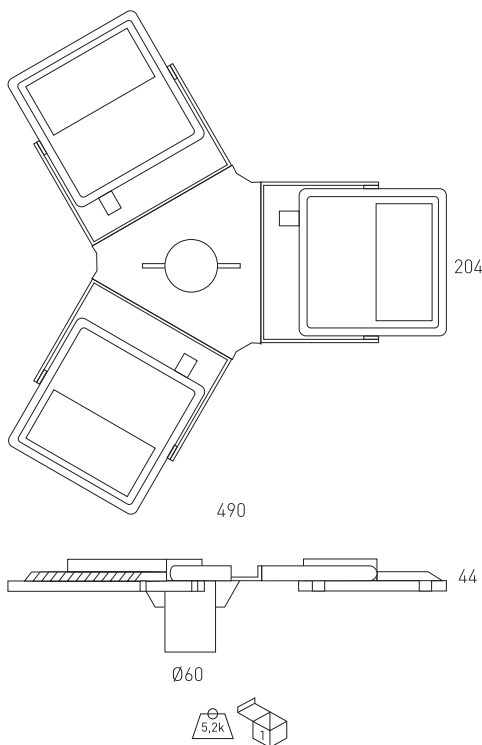

Protek City LED Trío / Protek City LED Trio

Incluye tres unidades Protek City LED y soporte Trío.
Includes three Protek City LED and Trio support .

Ref.	Color / Colour	Lamp.	Lumens	W	€	RAEE lum.
4178 01 16 85	Blanco / White	LED	6330	3x16w	527,90	0,60
4178 02 16 85	Negro / Black	LED	6330	3x16w	530,80	0,60
4178 58 16 85	Gris / Gray	LED	6330	3x16w	530,80	0,60
4178 01 25 85	Blanco / White	LED	9486	3x25w	543,50	0,60
4178 02 25 85	Negro / Black	LED	9486	3x25w	545,60	0,60
4178 58 25 85	Gris / Gray	LED	9486	3x25w	545,60	0,60
4178 01 50 85	Blanco / White	LED	19000	3x50w	663,20	0,60
4178 02 50 85	Negro / Black	LED	19000	3x50w	665,80	0,60
4178 58 50 85	Gris / Gray	LED	19000	3x50w	665,80	0,60

* Se suministra de manera estándar con lámpara 5700° K.
* Standardly supplied with 5700° K lamp.

Incremento por accesorios / Rough price increase of accessories		€
Ref. AM	Pintura especial ambiente marino / Special marine environment paint	110,00

RIPA LED

Grado de protección **IP65** / Índice de protección antivandálico **IK08**

Material:	Cuerpo fabricado en aluminio inyectado, granallado y con recubrimiento de pintura al horno de poliéster sin TGIC resistencia para exterior. Opcionalmente se suministra con pintura especial con resistencia para ambiente marino.
Óptica:	Ópticas de 80°/150° incluidas en las lámparas LED. Disponibles varias ópticas asimétricas Ledil (Finlandia). Cierre vidrio segurizado.
Alimentación:	Driver incluido en todos los modelos, factor de potencia >0,95. Puede suministrarse opcionalmente con driver 1-10V, Dali, driver regulable programable 5 niveles sin línea de mando, doble nivel sin línea de mando, regulación en cabecera.
Lámparas:	Módulo compuesto por LED Osram Oslon SSL con una potencia 29,4w, 42w, 45,4w 61,6w, 88w. Disponible en 3000°K, 4000°K o 5700°K. PCB en aluminio de alta pureza lacado en blanco 1,6mm con conectores rápidos.
Protecciones:	Sobretensiones estándar del driver 4KV, bajo pedido sobretensiones 10KV.
Vida útil:	L70B10 50.000horas
Instalación:	Sobre columna o báculo, Ø 60mm. (Otras dimensiones bajo pedido) Un conector eléctrico rápido de 3 o 5 polos, IP66, permite instalar la luminaria sin necesidad de abrirla.
Temp. Ambiente:	-20°C a 40°C. Se puede solicitar opcionalmente con sonda de temperatura NTC.
Colores:	Gris sablé similar RAL 7012. Disponible en otros colores RAL bajo pedido.

RIPA LED

Protection degree **IP65** / Impact protection index **IK08**

Material:	Body made of injected aluminum, blasting and polyester thermo painted without TGIC. Outdoor resistance. Optionally it can be supplied with special paint resistant to marine environment.
Optics:	80° / 150° optics included in LED lamps. Available several asymmetric optics LEDIL brand (Finland). Closure in safety glass.
Supply:	Driver included for all models, power factor > 0.95. It can be provided optionally with 1-10V dimmable driver, Dali dimmable driver, programmable dimmable driver with 5 levels without control line, double power level with no line of command, header regulation.
Lamps:	Osram LEDs module composed by Oslon SSL with a total power of 29,4w, 42w, 45,4w, 61,6w, and 88w. Available in 3000°K, 4000°K or 5700°K. High purity aluminium PCB from 1,6 mm. lacquered in white colour with quick connectors.
Protections:	Standard Surge protector of 4KV driver. Available 10KV surge on request.
Lifespan:	L70B10 50.000 hours.
Installation:	To mount on column or crosier. Luminaire adjustable in several orientation degrees. Ø 60mm. (Other dimensions on request). A quick connector of 3 or 5 poles, IP66, it allows the installation without opening the luminaire.
Ambient temp.:	-20° C to 40° C. Optionally supplied with NTC temperature probe.
Colours:	Sablé gray colour similar to RAL 7012. Available in other RAL colours on request.

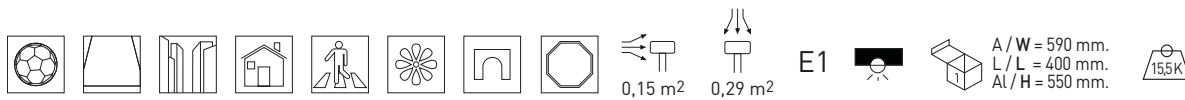

Ripa 28 LED - Óptica simétrica 150°
Ripa 28 LED - Symmetric optics 150°



Incluye driver y 28 LED / Includes driver and 28 LED

Ref.	Color / Colour	Lamp	W	mA	Lum.	€	RAEE lum.
3361 58 29 85	Gris / Gray	LED	29,4w	350	4479	533,90	0,60
3361 58 45 85	Gris / Gray	LED	45,4w	530	5823	571,90	0,60
3361 58 61 85	Gris / Gray	LED	61,6w	700	7839	596,60	0,60

* Se suministra de manera estándar con lámpara 5700°K.

* Standardly supplied with 5700°K.

Ripa 40 LED - Óptica simétrica 150°
Ripa 40 LED - Symmetric optics 150°



Incluye driver y 40 LED / Includes driver and 40 LED

Ref.	Color / Colour	Lamp	W	mA	Lum.	€	RAEE lum.
3361 58 42 85	Gris / Gray	LED	42w	350	6400	684,90	0,60
3361 58 88 85	Gris / Gray	LED	88w	700	11200	771,40	0,60

* Se suministra de manera estándar con lámpara 5700°K.

* Standardly supplied with 5700°K.

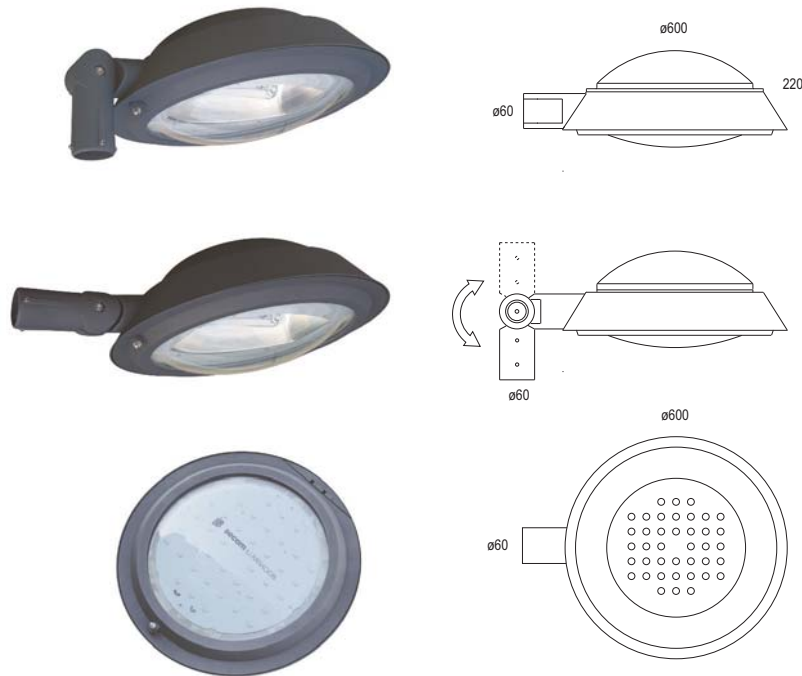

Grupo óptico IP65
Optic group IP65

Incremento respecto al driver / Rough price increase of accessories		29,4w	42w	45,4w	61,6w	88w
Ref. DR	Driver regulable 1 - 10v / Dimmable driver 1 - 10v	19,90	19,90	19,90	105,00	90,00
Ref. DRD	Driver regulable Dali / Dimmable driver Dali	90,00	115,00	30,00	30,00	55,00
Ref. DRP	Driver programable / Programmable driver	71,30	94,80	94,80	94,80	94,80
Ref. DRPNTC	Driver programable / Programmable driver	87,10	110,60	110,60	110,60	110,60
Ref. DRC	Regulación en cabecera / Regulation at the head	71,30	94,80	94,80	94,80	94,80
Ref. DN	Regulación doble nivel / Double level dimmable	40,00	42,00	42,00	160,00	130,00
Ref. 4160	Driver para funcionam. a 12Vdc. / Driver for 12Vdc operation	15,00	15,00	-	25,00	15,00

OPCIONES / OPTIONS

Incremento por óptica / Rough price increase of optics		29,4w	42w	45,4w	61,6w	88w
Ref. 3408	Óptica simétrica 80° / Symmetric optics 80°	3,20	4,80	3,20	3,20	4,80
Ref. 3407	Óptica asimétrica 150° / Asymmetric optics 150°	36,12	55,60	36,12	36,12	55,60
Ref. 3407 3408	Óptica asimétrica 80° / Asymmetric optics 80°	36,12	55,60	36,12	36,12	55,60
Ref. 3405	Óptica asimétrica Street / Asymmetric optics Street	78,10	99,80	78,10	78,10	99,80

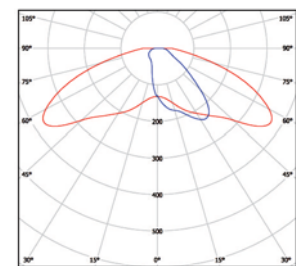

Ref. 3405 Óptica asimétrica Street
Asymmetric optical Street

ACCESORIOS /ACCESSORIES

Incremento por accesorios / Rough price increase of accessories		€
Ref. 3390	Protector de sobretensión / Surge protector	19,00
Ref. AM	Pintura especial ambiente marino / Special marine environment paint	90,00
Ref. 6033	Raco adaptador de 60 mm. a 33 mm. / Reducing adapter from 60mm. to 33mm.	38,00
Ref. 6048	Raco adaptador de 60 mm. a 48 mm. / Reducing adapter from 60mm. to 48mm.	41,00
Ref. 6076	Raco adaptador de 60 mm. a 76 mm. / Reducing adapter from 60mm. to 76mm.	43,00

OPCIONES LED / LED OPTIONS

	Ref. 83	Ref. 84	Ref. 85
CRI>70 / Temperatura de color / Colour temperature	3000°K	4000°K	5700°K
Osram Oslon SSL	•	•	•

Nº LEDs	W	mA	Lúmenes / Lumens		
			3000°K	4000°K	5700°K
28	29,4w	350	3047	4116	4479
28	45,4w	530	4115	5544	5823
28	61,6w	700	5180	7000	7839
40	42w	350	4360	5880	6400
40	88w	700	7400	10000	11200

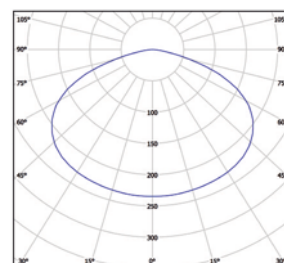

Óptica simétrica de 150°
Symmetric optical 150°

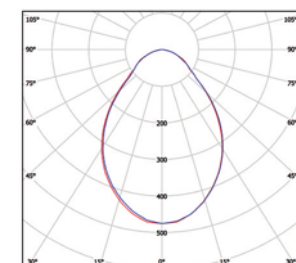

Ref. 3408 Óptica simétrica de 80°
Symmetric optical 80°

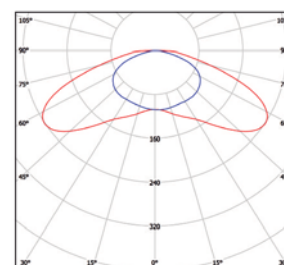

Ref. 3407 Óptica asimétrica de 150°
Asymmetric optical 150°

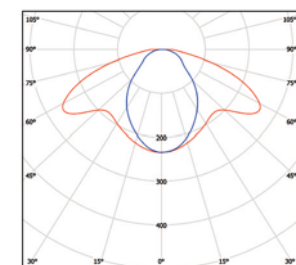

Ref. 3408 3407 Óptica asimétrica de 80°
Asymmetric optical 80°

RIPA

Grado de protección **IP65** / Índice de protección antivandálico **IK08**

Material:	Cuerpo de la luminaria en aluminio inyectado con recubrimiento de pintura al horno.
Óptica:	Reflector de aluminio para lámparas en posición horizontal con cristal protector securizado.
Alimentación:	Todos los modelos incluyen equipos y lámparas adecuados.
Lámparas:	Usa lámparas de sodio de alta presión, de sodio blanco y de halogenuro metálico.
Instalación:	Acoplamiento para montaje sobre columnas en posición horizontal, vertical o intermedia. $\varnothing 60$ mm.
Colores:	Gris. Disponible en otros colores RAL bajo pedido.

RIPA

Protection degree **IP65** / Impact protection index **IK08**

Material:	Body of the luminaire made in thermo painted injected aluminium.
Optics:	Aluminium reflector for lamps in horizontal position with secured glass closure.
Supply:	All models include control gear and lamps.
Lamps:	It uses high pressure lamps, white sodium lamps and halide lamps.
Installation:	Coupling for mounting in columns in horizontal, vertical or intermediate position. $\varnothing 60$ mm.
Colours:	Grey. It can be supplied in other RAL colours by request.

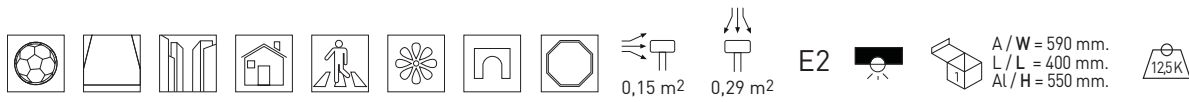

Ripa - Sodio de alta presión / High Pressure Sodium



Incluye equipo y lámpara SODIO ALTA PRESIÓN
Includes control gear and lamp HIGH PRESSURE SODIUM

Ref.	Color / Colour	Lamp	Port./ L/H	W	€	lum. RAE	lamp
3356 58 50	Gris / Gray	SON-T	E-27	50W	381,48	0,70	0,30
3356 58 70	Gris / Gray	SON-T	E-27	70W	382,20	0,70	0,30
3356 58 10	Gris / Gray	SON-T	E-40	100W	383,25	0,70	0,30
3356 58 15	Gris / Gray	SON-T	E-40	150W	396,58	0,70	0,30
3356 58 25	Gris / Gray	SON-T	E-40	250W	411,01	0,70	0,30

Ripa - Halogenuro metálico / Metal halide



Incluye equipo y lámpara HQI
Includes control gear and HQI lamp

Ref.	Color / Colour	Lamp	Port./ L/H	W	€	lum. RAE	lamp
3359 58 50	Gris / Gray	CDO TT	E-27	50W	429,45	0,70	0,30
3359 58 70	Gris / Gray	CDO TT	E-27	70W	433,86	0,70	0,30
3359 58 10	Gris / Gray	CDO TT	E-40	100W	437,74	0,70	0,30
3359 58 15	Gris / Gray	CDO TT	E-40	150W	442,05	0,70	0,30
3359 58 25	Gris / Gray	CDO TT	E-40	250W	517,54	0,70	0,30

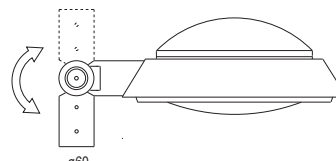
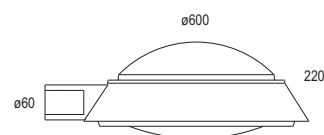

OPCIONES DE REGULACIÓN DOBLE NIVEL CON LÍNEA DE MANDO
DOUBLE LEVEL DIMMABLE WITH ADDITIONAL CONTROL WIRE OPTION

Incremento respecto a la luminaria NO regulable / Rough price increase of control gear		€
Ref. RLM70	Sodio alta presión / HQI 70W / High pressure sodium / HQI 70w	56,00
Ref. RLM100	Sodio alta presión / HQI 100W / High pressure sodium / HQI 100w	58,20
Ref. RLM150	Sodio alta presión / HQI 150W / High pressure sodium / HQI 150w	72,20
Ref. RLM250	Sodio alta presión / HQI 250W / High pressure sodium / HQI 250w	85,40

OPCIONES DE REGULACIÓN DOBLE NIVEL SIN LÍNEA DE MANDO
DOUBLE LEVEL DIMMABLE WITHOUT ADDITIONAL CONTROL WIRE OPTION

Incremento respecto a la luminaria NO regulable / Rough price increase of control gear		€
Ref. RSL50	Sodio alta presión / HQI 50W / High pressure sodium / HQI 50w	56,10
Ref. RSL70	Sodio alta presión / HQI 70W / High pressure sodium / HQI 70w	57,10
Ref. RSL100	Sodio alta presión / HQI 100W / High pressure sodium / HQI 100w	58,30
Ref. RSL150	Sodio alta presión / HQI 150W / High pressure sodium / HQI 150w	72,90
Ref. RSL250	Sodio alta presión / HQI 250W / High pressure sodium / HQI 250w	92,20

RAY BEN LED

Grado de protección **IP65** / Índice de protección antivandálico **IK08**

Material:	Cuerpo fabricado en aluminio inyectado, granallado y con recubrimiento de pintura al horno de poliéster sin TGIC resistencia para exterior. Opcionalmente se suministra con pintura especial con resistencia para ambiente marino.
Óptica:	Ópticas de 80°/150° incluidas en las lámparas LED. Disponibles varias ópticas asimétricas Ledil (Finlandia). Cierre vidrio securizado.
Alimentación:	Driver incluido en todos los modelos, factor de potencia >0,95. Puede suministrarse opcionalmente con driver 1-10V, Dali, driver regulable programable 5 niveles sin línea de mando, doble nivel sin línea de mando, regulación en cabecera.
Lámparas:	Módulo compuesto por LED Osram Oslon SSL con una potencia 29,4w, 42w, 45,4w 61,6w, 88w. Disponible en 3000°K, 4000°K o 5700°K. PCB en aluminio de alta pureza lacado en blanco 1,6mm con conectores rápidos.
Protecciones:	Sobretensiones estándar del driver 4KV, bajo pedido sobretensiones 10KV.
Vida útil:	L70B10 50.000 horas.
Instalación:	Sobre columna Ø 60mm. (Otras dimensiones bajo pedido) Un conector eléctrico rápido de 3 o 5 polos, IP66, permite instalar la luminaria sin necesidad de abrirla.
Temp. Ambiente:	-20°C a 40°C. Se puede solicitar opcionalmente con sonda de temperatura NTC.
Colores:	Gris sablé similar RAL 7012. Disponible en otros colores RAL bajo pedido.



Ray Ben 28 LED - Óptica simétrica 150°
Ray Ben 28 LED - Symmetric optics 150°

Incluye driver y 28 LED / Includes driver and 28 LED

Ref.	Color / Colour	Lamp	W	mA	Lum.	€	RAEE lum.
3369 58 29 85	Gris / Gray	LED	29,4w	350	4479	667,80	0,60
3369 58 45 85	Gris / Gray	LED	45,4w	530	5823	705,85	0,60
3369 58 61 85	Gris / Gray	LED	61,6w	700	7839	724,80	0,60

* Se suministra de manera estándar con lámpara 5700°K.

* Standardly supplied with 5700°K.

RAY BEN LED

Protection degree **IP65** / Impact protection index **IK08**

Material:	Body made of injected aluminum, blasting and polyester thermo painted without TGIC. Outdoor resistance. Optionally it can be supplied with special paint resistant to marine environment.
Optics:	80° / 150° optics included in LED lamps. Available several asymmetric optics LEDIL brand (Finland). Closure in safety glass.
Supply:	Driver included for all models, power factor > 0.95. It can be provided optionally with 1-10V dimmable driver, Dali dimmable driver, programmable dimmable driver with 5 levels without control line, double power level with no line of command, header regulation.
Lamps:	Osram LEDs module composed by Oslon SSL with a total power of 29,4w, 42w, 45,4w, 61,6w, and 88w. Available in 3000°K, 4000°K or 5700°K. High purity aluminium PCB from 1,6 mm. lacquered in white colour with quick connectors.
Protections:	Internal protection with individual diode for each LED. Standard Surge protector of 4KV driver. Available 10KV surge on request.
Lifespan:	L70B10 50.000 hours.
Installation:	To mount on column or crossier. Luminaire adjustable in several orientation degrees. Ø 60mm. (Other dimensions on request). A quick connector of 3 or 5 poles, IP66, it allows the installation without opening the luminaire.
Ambient tem.:	-20° C to 40° C. Optionally supplied with NTC temperature probe.
Colours:	Sablé gray colour similar to RAL 7012. Available in other RAL colours on request.

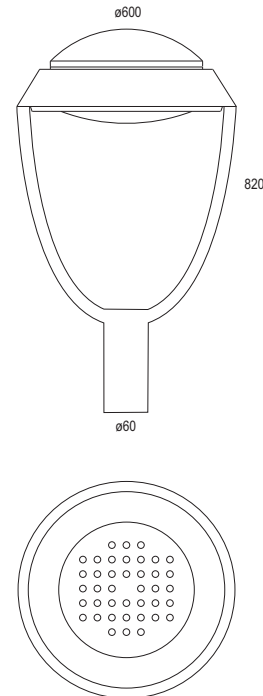

Ray Ben 40 LED - Óptica simétrica 150°
Ray Ben 40 LED - Symmetric optics 150°

Incluye driver y 40 LED / Includes driver and 40 LED

Ref.	Color / Colour	Lamp	W	mA	Lum.	€	RAEE lum.
3369 58 42 85	Gris / Gray	LED	42w	350	6400	758,60	0,60
3369 58 88 85	Gris / Gray	LED	88w	700	11200	821,75	0,60

* Se suministra de manera estándar con lámpara 5700°K.

* Standardly supplied with 5700°K.

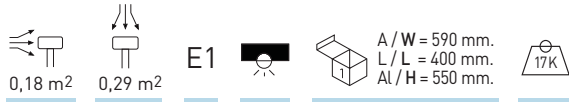

Incremento respecto al driver / Rough price increase of accessories		29,4w	42w	45,4w	61,6w	88w
Ref. DR	Driver regulable 1 - 10v / Dimmable driver 1 - 10v	19,90	19,90	19,90	105,00	90,00
Ref. DRD	Driver regulable Dali / Dimmable driver Dali	90,00	115,00	30,00	30,00	55,00
Ref. DRP	Driver programable / Programmable driver	71,30	94,80	94,80	94,80	94,80
Ref. DRPNTC	Driver prog. y sonda Tª NTC / Prog. driver & NTC control	87,10	110,60	110,60	110,60	110,60
Ref. DRC	Regulación en cabecera / Regulation at the head	71,30	94,80	94,80	94,80	94,80
Ref. DN	Regulación doble nivel / Double level dimmable	40,00	42,00	42,00	160,00	130,00
Ref. 4160	Driver para funcionam. a 12Vdc. / Driver for 12Vdc operation	15,00	15,00	-	25,00	25,00

OPCIONES / OPTIONS

Incremento por óptica / Rough price increase of optics		29,4w	42w	45,4w	61,6w	88w
Ref. 3408	Óptica simétrica 80° / Symmetric optics 80°	3,20	4,80	3,20	3,20	4,80
Ref. 3407	Óptica asimétrica 150° / Asymmetric optics 150°	36,12	55,60	36,12	36,12	55,60
Ref. 3407/3408	Óptica asimétrica 80° / Asymmetric optics 80°	36,12	55,60	36,12	36,12	55,60
Ref. 3405	Óptica asimétrica Street / Asymmetric optics Street	78,10	99,80	78,10	78,10	99,80

ACCESORIOS / ACCESSORIES

Incremento por accesorios / Rough price increase of accessories		€
Ref. 3390	Protector de sobretensión / Surge protector	19,00
Ref. AM	Pintura especial ambiente marino / Special marine environment paint	110,00

OPCIONES LED / LED OPTIONS	Ref. 83	Ref. 84	Ref. 85
CRI>70 / Temperatura de color / Colour temperature	3000°K	4000°K	5700°K
Osram Oslon SSL	•	•	•

Nº LEDs	W	mA	Lúmenes / Lumens		
			3000°K	4000°K	5700°K
28	29,4w	350	3047	4116	4479
28	45,4w	530	4115	5544	5823
28	61,6w	700	5180	7000	7839
40	42w	350	4360	5880	6400
40	88w	700	7400	10000	11200

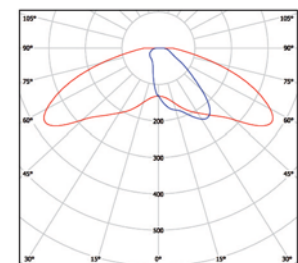

Ref. 3405 Óptica asimétrica Street
Asymmetric optical Street

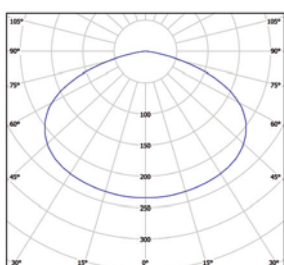

Óptica simétrica de 150°
Symmetric optical 150°

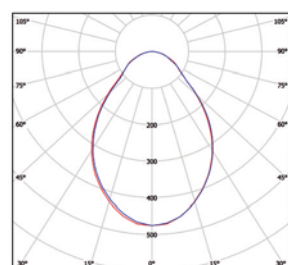

Ref. 3408 Óptica simétrica de 80°
Symmetric optical 80°

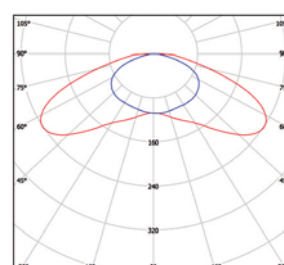

Ref. 3407 Óptica asimétrica de 150°
Asymmetric optical 150°

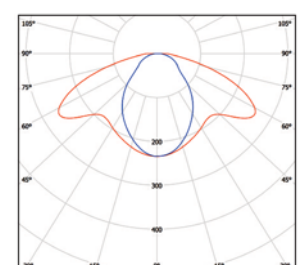

Ref. 3408/3407 Óptica asimétrica de 80°
Asymmetric optical 80°

RAY BEN

Grado de protección **IP65** / Índice de protección antivandálico **IK08**

Material:	Cuerpo de la luminaria en aluminio inyectado con recubrimiento de pintura al horno.
Óptica:	Reflector de aluminio para lámparas en posición horizontal con cristal protector hermético.
Alimentación:	Incluye equipo adecuado al tipo de lámpara y potencia a usar.
Lámparas:	Lámparas de sodio de alta presión, de sodio blanco y de halogenuro metálico.
Instalación:	Acoplamiento para montaje sobre columnas. ø60mm.
Colores:	Gris. Disponible en otros colores RAL bajo pedido.



RAY BEN

Protection degree **IP65** / Impact protection index **IK08**

Material:	Body of the luminaire made in thermo painted injected aluminium.
Optics:	Aluminium reflector for lamps in horizontal position with sealed protector glass.
Supply:	All models include control gear and lamps.
Lamps:	It uses high pressure lamps, white sodium lamps and halide lamps.
Installation:	Coupling for mounting in columns. ø60mm.
Colours:	Grey. It can be supplied in other RAL colours by request.

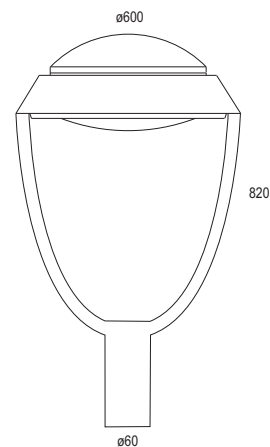

RAY BEN - LUMINARIA VACÍA / EMPTY LAMP

€

Ref. 3600 58	Luminaria vacía con cierre de cristal segurizado y reflector IP65 Empty lamp with tempered glass closing and IP65 reflector	402,90
---------------------	--	---------------

Ray Ben - Sodio de alta presión / High Pressure Sodium



Incluye equipo y lámpara SODIO ALTA PRESIÓN
Includes control gear and HIGH PRESSURE SODIUM lamp

Ref.	Color / Colour	Lamp	Port./ L/H	W	€	RAEE lum.	RAEE lamp
3364 58 50	Gris / Gray	SON-T	E-27	50W	529,74	0,70	0,30
3364 58 70	Gris / Gray	SON-T	E-27	70W	530,46	0,70	0,30
3364 58 10	Gris / Gray	SON-T	E-40	100W	532,01	0,70	0,30
3364 58 15	Gris / Gray	SON-T	E-40	150W	544,84	0,70	0,30
3364 58 25	Gris / Gray	SON-T	E-40	250W	559,23	0,70	0,30

Ray Ben - Halogenuro metálico / Metal halide



Incluye equipo y lámpara HQI
Includes control gear and HQI lamp

Ref.	Color / Colour	Lamp	Port./ L/H	W	€	RAEE lum.	RAEE lamp
3367 58 50	Gris / Gray	CDO TT	E-27	50W	577,71	0,70	0,30
3367 58 70	Gris / Gray	CDO TT	E-27	70W	582,12	0,70	0,30
3367 58 10	Gris / Gray	CDO TT	E-40	100W	586,00	0,70	0,30
3367 58 15	Gris / Gray	CDO TT	E-40	150W	590,31	0,70	0,30
3367 58 25	Gris / Gray	CDO TT	E-40	250W	666,85	0,70	0,30

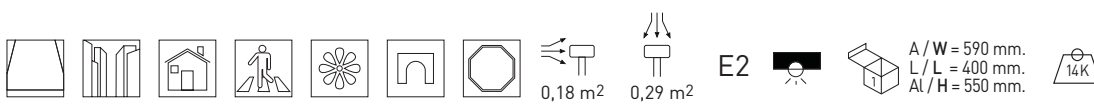

OPCIONES DE REGULACIÓN DOBLE NIVEL CON LÍNEA DE MANDO
DOUBLE LEVEL DIMMABLE WITH ADDITIONAL CONTROL WIRE OPTION

Incremento respecto a la luminaria	NO regulable / Rough price increase of control gear	€
Ref. RLM70	Sodio alta presión / HQI 70W / High pressure sodium / HQI 70w	56,00
Ref. RLM100	Sodio alta presión / HQI 100W / High pressure sodium / HQI 100w	58,20
Ref. RLM150	Sodio alta presión / HQI 150W / High pressure sodium / HQI 150w	72,20
Ref. RLM250	Sodio alta presión / HQI 250W / High pressure sodium / HQI 250w	85,40

OPCIONES DE REGULACIÓN DOBLE NIVEL SIN LÍNEA DE MANDO
DOUBLE LEVEL DIMMABLE WITHOUT ADDITIONAL CONTROL WIRE OPTION

Incremento respecto a la luminaria	NO regulable / Rough price increase of control gear	€
Ref. RSL50	Sodio alta presión / HQI 50W / High pressure sodium / HQI 50w	56,10
Ref. RSL70	Sodio alta presión / HQI 70W / High pressure sodium / HQI 70w	57,10
Ref. RSL100	Sodio alta presión / HQI 100W / High pressure sodium / HQI 100w	58,30
Ref. RSL150	Sodio alta presión / HQI 150W / High pressure sodium / HQI 150w	72,90
Ref. RSL250	Sodio alta presión / HQI 250W / High pressure sodium / HQI 250w	92,20

▸ ILUMINACIÓN
URBANA

▸ URBAN
LIGHTING





URA LED

Grado de protección **IP65** / Índice de protección antivandálico **IK08**

Material: Cuerpo fabricado en aluminio con recubrimiento de pintura al horno de poliéster sin TGIC resistencia para exterior. Opcionalmente se suministra con pintura especial con resistencia para ambiente marino.

Óptica: Ópticas de 80°/150° incluidas en las lámparas LED. Disponibles varias ópticas asimétricas Ledil (Finlandia). Cierre en metacrilato (PMMA) para LED de gran paso de luz y resistencia UV.

Alimentación: Driver incluido en todos los modelos, factor de potencia >0,95. Puede suministrarse opcionalmente con driver 1-10V, Dali, driver regulable programable 5 niveles sin línea de mando, doble nivel sin línea de mando, regulación en cabecera.

Lámparas: Módulo compuesto por LED Osram Oslon SSL con una potencia 29,4w, 42w, 45,4w 61,6w, 88w. Disponible en 3000°K, 4000°K o 5700°K. PCB en aluminio de alta pureza lacado en blanco 1,6mm con conectores rápidos.

Protecciones: +Sobretensiones estándar del driver 4KV, bajo pedido sobretensiones 10KV.

Vida útil: L70B10 60.000 horas.

Instalación: Acoplamiento sobre columna Ø ¾".

Temp. Ambiente: -20°C a 40°C. Se puede solicitar opcionalmente con sonda de temperatura NTC.

Colores: Negro con tornillería en latón. Disponible en otros colores RAL bajo pedido.



Ura 28 LED - Óptica simétrica 150° - Sin cierres
Ura 28 LED - Symmetric optics 150° - Without closing

Incluye driver y 28 LED
Includes driver and 28 LED

Ref.	Color / Colour	Lamp	W	mA	Lum.	€	RAEE lum.
3330 02 29 85 00	Negro / Black	LED	29,4w	350	4479	418,30	0,60
3330 02 45 85 00	Negro / Black	LED	45,4w	530	5853	490,20	0,60
3330 02 61 85 00	Negro / Black	LED	61,6w	700	7839	531,14	0,60

* Se suministra de manera estándar con lámpara 5700°K.

* Standardly supplied with 5700°K.



Ura 28 LED - Óptica simétrica 150° - Policarbonato mate
Ura 28 LED - Symmetric optics 150° - Matt polycarbonate

Incluye driver y 28 LED
Includes driver and 28 LED

Ref.	Color / Colour	Lamp	W	mA	Lum.	€	RAEE lum.
3330 02 29 85 01	Negro / Black	LED	29,4w	350	4479	471,58	0,60
3330 02 45 85 01	Negro / Black	LED	45,4w	530	5823	514,40	0,60
3330 02 61 85 01	Negro / Black	LED	61,6w	700	7839	544,60	0,60

* Se suministra de manera estándar con lámpara 5700°K.

* Standardly supplied with 5700°K.



Ura 28 LED - Óptica simétrica 150° - Policarbonato transparente
Ura 28 LED - Symmetric optics 150° - Transparent polycarbonate

Incluye driver y 28 LED
Includes driver and 28 LED

Ref.	Color / Colour	Lamp	W	mA	Lum.	€	RAEE lum.
3330 02 29 85 02	Negro / Black	LED	29,4w	350	4479	475,60	0,60
3330 02 45 85 02	Negro / Black	LED	45,4w	530	5823	515,50	0,60
3330 02 61 85 02	Negro / Black	LED	61,6w	700	7839	545,60	0,60

* Se suministra de manera estándar con lámpara 5700°K.

* Standardly supplied with 5700°K.

URA LED

Protection degree **IP65** / Impact protection index **IK08**

Material: Body made of injected aluminum, blasting and polyester thermo painted without TGIC. Outdoor resistance. Optionally it can be supplied with special paint resistant to marine environment.

Optics: 80° / 150° optics included in LED lamps. Available several asymmetric optics LEDIL brand (Finland). Closure in methacrylate (PMMA) for good light path LEDs and UV resistance.

Supply: Driver included for all models, power factor > 0.95. It can be provided optionally with 1-10V dimmable driver, Dali dimmable driver, programmable dimmable driver with 5 levels without control line, double power level with no line of command, header regulation.

Lamps: Osram LEDs module composed by Oslon SSL with a total power of 29,4w, 42w, 45,4w, 61,6w, and 88w. Available in 3000°K, 4000°K or 5700°K. High purity aluminium PCB from 1,6 mm. lacquered in white colour with quick connectors.

Protections: Standard Surge protector of 4KV driver. Available 10KV surge on request.

Lifespan: L70B10 60.000 hours.

Installation: To mount on column Ø ¾".

Ambient temp.: -20° C to 40° C. Optionally supplied with NTC temperature probe.

Colours: Black luminaire with brass screws. Available in other RAL colours on request.



Ura 40 LED - Óptica simétrica 150° - Sin cierres
Ura 40 LED - Symmetric optics 150° - Without closing

Incluye driver y 40 LED
Includes driver and 40 LED

Ref.	Color / Colour	Lamp	W	mA	Lum.	€	RAEE lum.
3330 02 42 85 00	Negro / Black	LED	42w	350	6400	498,80	0,60
3330 02 88 85 00	Negro / Black	LED	88w	700	11200	569,50	0,60

* Se suministra de manera estándar con lámpara 5700°K.

* Standardly supplied with 5700°K.



Ura 40 LED - Óptica simétrica 150° - Policarbonato mate
Ura 40 LED - Symmetric optics 150° - Matt polycarbonate

Incluye luminaria, driver y 40 LED
Includes driver and 40 LED

Ref.	Color / Colour	Lamp	W	mA	Lum.	€	RAEE lum.
3330 02 42 85 01	Negro / Black	LED	42w	350	6400	546,20	0,60
3330 02 88 85 01	Negro / Black	LED	88w	700	11200	624,00	0,60

* Se suministra de manera estándar con lámpara 5700°K.

* Standardly supplied with 5700°K.



Ura 40 LED - Óptica simétrica 150° - Policarbonato transparente
Ura 40 LED - Symmetric optics 150° - Transparent polycarbonate

Incluye luminaria, driver y 40 LED
Includes driver and 40 LED

Ref.	Color / Colour	Lamp	W	mA	Lum.	€	RAEE lum.
3330 02 42 85 02	Negro / Black	LED	42w	350	6400	547,20	0,60
3330 02 88 85 02	Negro / Black	LED	88w	700	11200	625,00	0,60

* Se suministra de manera estándar con lámpara 5700°K.

* Standardly supplied with 5700°K.

OPCIONES LED / LED OPTIONS	Ref. 83	Ref. 84	Ref. 85
CRI>70 / Temperatura de color / Colour temperature	3000°K	4000°K	5700°K
Osram Oslon SSL	•	•	•

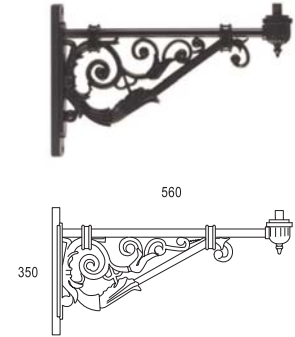
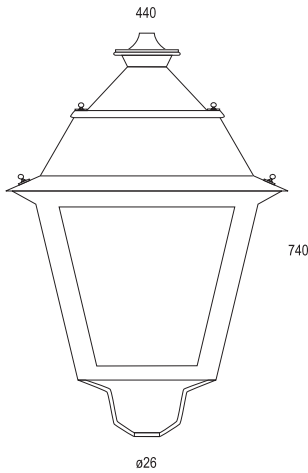

Ref. 3331
Brazo a pared / Wall-adapter

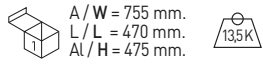
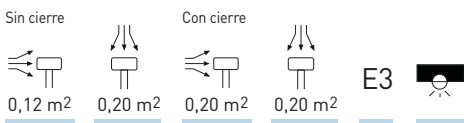

ACCESORIOS / ACCESSORIES

Incremento por accesorios / Rough price increase of accessories	€
Ref. 3390 Protector de sobretensión / Surge protector	19,00
Ref. AM Pintura especial ambiente marino / Special marine environment paint	100,00

OPCIONES / OPTIONS

Incremento por óptica / Rough price increase of optics	28 LEDs	40 LEDs
Ref. 3408 Óptica simétrica 80° / Symmetric optics 80°	3,20	4,80
Ref. 3407 Óptica asimétrica / Asymmetric optics	36,12	55,60

ACCESORIOS / ACCESSORIES

Incremento por accesorios / Rough price increase of accessories	€
Ref. 3331 Brazo a pared para luminarias sustentadas / Wall-adapter for sustained lamps	95,20
Ref. 3335 Racor adaptador para columna de ø60mm / Reducing adapter for posts ø60mm	49,90



Grupo óptico IP65
Optic group IP65.

Nº LEDs	W	mA	Lúmenes / Lumens		
			3000°K	4000°K	5700°K
28	29,4w	350	3047	4116	4479
28	45,4w	530	4115	5544	5823
28	61,6w	700	5180	7000	7839
40	42w	350	4360	5880	6400
40	88w	700	7400	10000	11200

Incremento respecto al driver / Rough price increase of accessories	29,4w	42w	45,4w	61,6w	88w
Ref. DR Driver regulable 1 - 10v / Dimmable driver 1 - 10v	19,90	19,90	19,90	105,00	90,00
Ref. DRD Driver regulable Dali / Dimmable driver Dali	90,00	115,00	30,00	30,00	55,00
Ref. DRP Driver programable / Programmable driver	71,30	94,80	94,80	94,80	94,80
Ref. DRPNTC Driver prog. y sonda Tª NTC / Prog. driver & NTC control	87,10	110,60	110,60	110,60	110,60
Ref. 4160 Driver para funcionam. a 12Vdc. / Driver for 12Vdc operation	15,00	15,00	-	25,00	15,00

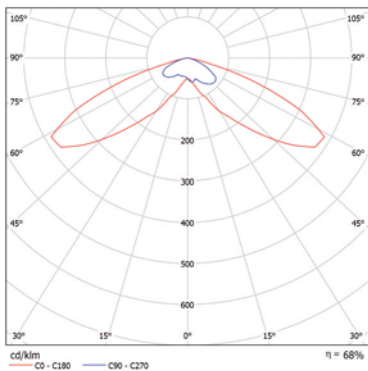

Ura LED con óptica asimétrica 150° sin cierre o con cierre de policarbonato transparente.
Ura LED asymmetric optics 150° without closure or closure of transparent polycarbonate.

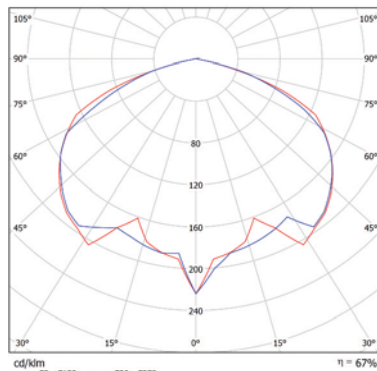

Ura LED con óptica simétrica 150° sin cierre o con cierre de policarbonato transparente.
FHS: 0,04%
Ura LED symmetric optics 150° without closure or closure of transparent polycarbonate.

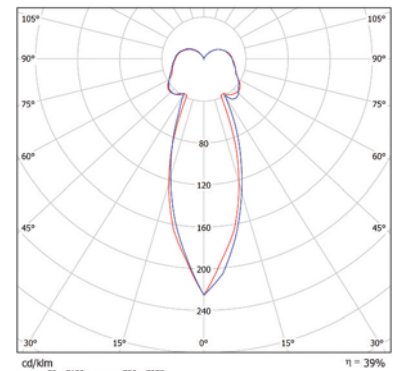

Ura LED con óptica simétrica 150° y cierre de policarbonato mate.
FHS: 24,8%
Ura LED symmetric optics 150° and closure of matte polycarbonate.

URA

Grado de protección grupo óptico **IP65** / Grado de protección receptáculo portaequipos **IP44**
Índice de protección antivandálico **IK08**

Material:	Cuerpo de la luminaria en aluminio con recubrimiento de pintura al horno.
Óptica:	Reflector de aluminio para lámparas en posición horizontal y cristal protector hermético. Se puede suministrar sin cierres, con cierre opal mate o con cierre de policarbonato transparente. Grupo óptico IP65.
Alimentación:	Todos los modelos incluyen equipos y lámparas adecuados.
Lámparas:	Admite lámparas de sodio de alta presión, de sodio blanco y de halogenuro metálico.
Instalación:	Acoplamiento para montaje sobre columnas. 3/4"
Colores:	Negro con tornillería en latón.

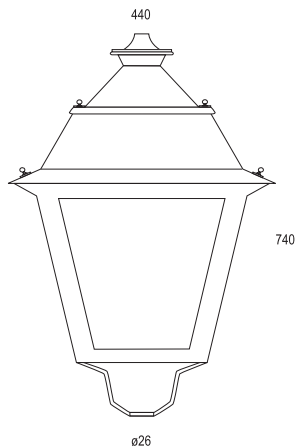

URA - LUMINARIA VACIA / URA - EMPTY LAMP		€
Ref. 3322 02 00	Luminaria vacía y sin cierres con reflector IP65 Empty lamp without protective closing IP65 reflector	188,10
Ref. 3322 02 01	Luminaria vacía con juego de cierres opal mate y reflector IP65 Empty lamp with protective matt closing IP65	195,60
Ref. 3322 02 02	Luminaria vacía con juego de cierres policarbonato transparente y reflector IP65 Empty lamp with transparent polycarbonate closing IP65	195,70

Ura - Sodio de alta presión - Sin cierres
Ura - High Pressure Sodium - Without closing



Incluye equipo y lámpara SODIO ALTA PRESIÓN
Includes control gear and lamp HIGH PRESSURE SODIUM

Ref.	Color / Colour	Lamp	Port./ L/H	W	€	RAEE lum. lamp	
3323 02 50 00	Negro / Black	SON-T	E-27	50W	308,52	0,70	0,30
3323 02 70 00	Negro / Black	SON-T	E-27	70W	309,20	0,70	0,30
3323 02 10 00	Negro / Black	SON-T	E-40	100W	310,68	0,70	0,30
3323 02 15 00	Negro / Black	SON-T	E-40	150W	322,90	0,70	0,30

Incluye equipo y lámpara HQI / Includes control gear and HQI lamp

Ref.	Color / Colour	Lamp	Port./ L/H	W	€	RAEE lum. lamp	
3326 02 50 00	Negro / Black	CDO TT	E-27	50W	354,20	0,70	0,30
3326 02 70 00	Negro / Black	CDO TT	E-27	70W	358,40	0,70	0,30
3326 02 10 00	Negro / Black	CDO TT	E-40	100W	362,10	0,70	0,30

URA

Protection degree optic group **IP65** / Protection degree container equipment **IP44**
Impact protection index **IK08**

Material:	Body of the luminaire made in thermo painted aluminium.
Optics:	Aluminium reflector for horizontal position lamps and protector sealed glass. It can be supplied without closure, with matt opal closure or with transparent polycarbonate closure. IP65 polycarbonate optic group.
Supply:	All models include control gear and lamps.
Lamps:	It uses high pressure sodium lamps, white sodium lamps, and metallic halide lamps.
Installation:	Coupling for mounting in columns. 3/4"
Colours:	Black with copper screw.



Ura - Sodio de alta presión - Policarbonato mate
Ura - High Pressure Sodium - Matt polycarbonate



Incluye equipo y lámpara SODIO ALTA PRESIÓN
Includes control gear and lamp HIGH PRESSURE SODIUM

Ref.	Color / Colour	Lamp	Port./ L/H	W	€	RAEE lum. lamp	
3323 02 50 01	Negro / Black	SON-T	E-27	50W	316,62	0,70	0,30
3323 02 70 01	Negro / Black	SON-T	E-27	70W	317,30	0,70	0,30
3323 02 10 01	Negro / Black	SON-T	E-40	100W	318,78	0,70	0,30
3323 02 15 01	Negro / Black	SON-T	E-40	150W	331,00	0,70	0,30

Incluye equipo y lámpara HQI / Includes control gear and HQI lamp

Ref.	Color / Colour	Lamp	Port./ L/H	W	€	RAEE lum. lamp	
3326 02 50 01	Negro / Black	CDO TT	E-27	50W	362,30	0,70	0,30
3326 02 70 01	Negro / Black	CDO TT	E-27	70W	366,50	0,70	0,30
3326 02 10 01	Negro / Black	CDO TT	E-40	100W	370,20	0,70	0,30



Ura - Sodio de alta presión - Policarbonato transparente
Ura - High Pressure Sodium - Transparent polycarbonate



Incluye equipo y lámpara SODIO ALTA PRESIÓN
Includes control gear and lamp HIGH PRESSURE SODIUM

Ref.	Color / Colour	Lamp	Port./ L/H	W	€	RAEE lum. lamp	
3323 02 50 02	Negro / Black	SON-T	E-27	50W	316,72	0,70	0,30
3323 02 70 02	Negro / Black	SON-T	E-27	70W	317,40	0,70	0,30
3323 02 10 02	Negro / Black	SON-T	E-40	100W	318,88	0,70	0,30
3323 02 15 02	Negro / Black	SON-T	E-40	150W	331,10	0,70	0,30

Incluye equipo y lámpara HQI / Includes control gear and HQI lamp

Ref.	Color / Colour	Lamp	Port./ L/H	W	€	RAEE lum. lamp	
3326 02 50 02	Negro / Black	CDO TT	E-27	50W	362,40	0,70	0,30
3326 02 70 02	Negro / Black	CDO TT	E-27	70W	366,60	0,70	0,30
3326 02 10 02	Negro / Black	CDO TT	E-40	100W	370,30	0,70	0,30



Grupo óptico IP65 con lámp. horizontal
Optic group IP65 with lamp horizontal

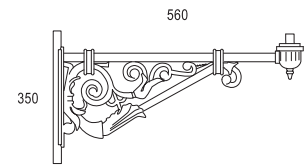

Ref. 3331
Brazo a pared / Wall-adapter

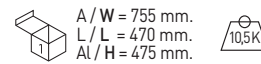
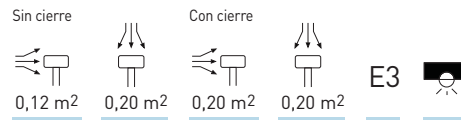

ACCESORIOS / ACCESSORIES

Incremento por accesorios / Rough price increase of accessories		€
Ref. 3331	Brazo a pared para luminarias sustentadas Wall-adapter for sustained lamps	95,20
Ref. 3335	Racor adaptador para columna de ø60mm Reducing adapter for posts ø60mm	49,90

OPCIONES DE REGULACIÓN DOBLE NIVEL CON LÍNEA DE MANDO DOUBLE LEVEL DIMMABLE WITH ADDITIONAL CONTROL WIRE OPTION

Incremento respecto a la luminaria NO regulable / Rough price increase of control gear		€
Ref. RLM70	Sodio alta presión / HQI 70W / High pressure sodium / HQI 70w	56,00
Ref. RLM100	Sodio alta presión / HQI 100W / High pressure sodium / HQI 100w	58,20
Ref. RLM150	Sodio alta presión / HQI 150W / High pressure sodium / HQI 150w	72,20
Ref. RLM250	Sodio alta presión / HQI 250W / High pressure sodium / HQI 250w	85,40

OPCIONES DE REGULACIÓN DOBLE NIVEL SIN LÍNEA DE MANDO DOUBLE LEVEL DIMMABLE WITHOUT ADDITIONAL CONTROL WIRE OPTION

Incremento respecto a la luminaria NO regulable / Rough price increase of control gear		€
Ref. RSL50	Sodio alta presión / HQI 50W / High pressure sodium / HQI 50w	56,10
Ref. RSL70	Sodio alta presión / HQI 70W / High pressure sodium / HQI 70w	57,10
Ref. RSL100	Sodio alta presión / HQI 100W / High pressure sodium / HQI 100w	58,30
Ref. RSL150	Sodio alta presión / HQI 150W / High pressure sodium / HQI 150w	72,90
Ref. RSL250	Sodio alta presión / HQI 250W / High pressure sodium / HQI 250w	92,20



PAR
DE



REGAL LED

Grado de protección IP65 / Índice de protección antivandálico IK08

Material: Cuerpo fabricado en aluminio con recubrimiento de pintura al horno de poliéster sin TGIC resistencia para exterior. Opcionalmente se suministra con pintura especial con resistencia para ambiente marino.

Óptica: Ópticas de 80°/150° incluidas en las lámparas LED. Disponibles varias ópticas asimétricas Ledil (Finlandia). Cierre en metacrilato (PMMA) para LED de gran paso de luz y resistencia UV.

Alimentación: Driver incluido en todos los modelos, factor de potencia >0,95. Puede suministrarse opcionalmente con driver 1-10V, Dali, driver regulable programable 5 niveles sin línea de mando, doble nivel sin línea de mando, regulación en cabecera.

Lámparas: Módulo compuesto por LED Osram Oslon SSL con una potencia 29,4w, 42w, 45,4w 61,6w, 88w. Disponible en 3000°K, 4000°K o 5700°K. PCB en aluminio de alta pureza lacado en blanco 1,6mm con conectores rápidos.

Protecciones: Sobretensiones estándar del driver 4KV, bajo pedido sobretensiones 10KV.

Vida útil: L70B10 60.000 horas.

Instalación: Acoplamiento sobre columna Ø ¾".

Temp. Ambiente: -20°C a 40°C. Se puede solicitar opcionalmente con sonda de temperatura NTC.

Colores: Negro. Disponible en otros colores RAL bajo pedido.

Opciones: Disponibles grupos ópticos para sustitución.



Regal 28 LED - Óptica simétrica 150° - Sin cierre
Regal 28 LED - Symmetric optics 150° - Without closing

Incluye driver y 28 LED / Includes driver and 28 LED

Ref.	Color / Colour	Lamp	W	mA	Lum.	€	RAEE lum.
3341 02 29 85 00	Negro / Black	LED	29,4w	350	4479	557,65	0,60
3341 02 45 85 00	Negro / Black	LED	45,4w	530	5823	591,85	0,60
3341 02 61 85 00	Negro / Black	LED	61,6w	700	7839	607,05	0,60

* Se suministra de manera estándar con lámpara 5700°K.
* Standardly supplied with 5700°K.



Regal 28 LED - Óptica simétrica 150° - Policarbonato prismático
Regal 28 LED - Symmetric optics 150° - Prismatic polycarbonate

Incluye driver y 28 LED / Includes driver and 28 LED

Ref.	Color / Colour	Lamp	W	mA	Lum.	€	RAEE lum.
3341 02 29 85 02	Negro / Black	LED	29,4w	350	4479	566,20	0,60
3341 02 45 85 02	Negro / Black	LED	45,4w	530	5823	604,20	0,60
3341 02 61 85 02	Negro / Black	LED	61,6w	700	7839	628,90	0,60

* Se suministra de manera estándar con lámpara 5700°K.
* Standardly supplied with 5700°K.



Regal 28 LED - Óptica simétrica 150° - Policarbonato transparente
Regal 28 LED - Symmetric optics 150° - Transparent polycarbonate

Incluye driver y 28 LED / Includes driver and 28 LED

Ref.	Color / Colour	Lamp	W	mA	Lum.	€	RAEE lum.
3341 02 29 85 03	Negro / Black	LED	29,4w	350	4479	566,20	0,60
3341 02 45 85 03	Negro / Black	LED	45,4w	530	5823	604,20	0,60
3341 02 61 85 03	Negro / Black	LED	61,6w	700	7839	628,90	0,60

* Se suministra de manera estándar con lámpara 5700°K.
* Standardly supplied with 5700°K.

REGAL LED

Protection degree IP65 / Impact protection index IK08

Material: Body made of injected aluminum, blasting and polyester thermo painted without TGIC. Outdoor resistance. Optionally it can be supplied with special paint resistant to marine environment.

Optics: 80° / 150° optics included in LED lamps. Available several asymmetric optics LEDIL brand (Finland). Closure in methacrylate (PMMA) for good light path LEDs and UV resistance.

Supply: Driver included for all models, power factor > 0.95. It can be provided optionally with 1-10V dimmable driver, Dali dimmable driver, programmable dimmable driver with 5 levels without control line, double power level with no line of command, header regulation.

Lamps: Osram LEDs module composed by Oslon SSL with a total power of 29,4w, 42w, 45,4w, 61,6w, and 88w. Available in 3000°K, 4000°K or 5700°K. High purity aluminium PCB from 1,6 mm. lacquered in white colour with quick connectors.

Protections: Standard Surge protector of 4KV driver. Available 10KV surge on request.

Lifespan: L70B10 60.000 hours.

Installation: To mount on column Ø ¾".

Ambient tem.: -20° C to 40° C. Optionally supplied with NTC temperature probe.

Colours: Black luminaire. Available in other RAL colours on request.

Options: Several optical compartment available to replace.



Regal 40 LED - Óptica simétrica 150° - Sin cierre
Regal 40 LED - Symmetric optics 150° - Without closing

Incluye driver y 40 LED / Includes driver and 40 LED

Ref.	Color / Colour	Lamp	W	mA	Lum.	€	RAEE lum.
3341 02 42 85 00	Negro / Black	LED	42w	350	6400	640,00	0,60
3341 02 88 85 00	Negro / Black	LED	88w	700	11200	673,20	0,60

* Se suministra de manera estándar con lámpara 5700°K.
* Standardly supplied with 5700°K.



Regal 40 LED - Óptica simétrica 150° - Policarbonato prismático
Regal 40 LED - Symmetric optics 150° - Prismatic polycarbonate

Incluye driver y 40 LED / Includes driver and 40 LED

Ref.	Color / Colour	Lamp	W	mA	Lum.	€	RAEE lum.
3341 02 42 85 02	Negro / Black	LED	42w	350	6400	649,70	0,60
3341 02 88 85 02	Negro / Black	LED	88w	700	11200	730,60	0,60

* Se suministra de manera estándar con lámpara 5700°K.
* Standardly supplied with 5700°K.



Regal 40 LED - Óptica simétrica 150° - Policarbonato transparente
Regal 40 LED - Symmetric optics 150° - Transparent polycarbonate

Incluye driver y 40 LED / Includes driver and 40 LED

Ref.	Color / Colour	Lamp	W	mA	Lum.	€	RAEE lum.
3341 02 42 85 03	Negro / Black	LED	42w	350	6400	649,70	0,60
3341 02 88 85 03	Negro / Black	LED	88w	700	11200	730,60	0,60

* Se suministra de manera estándar con lámpara 5700°K.
* Standardly supplied with 5700°K.



Grupo óptico IP65
Optic group IP65



Sin cierre	Con cierre		
0,17 m ²	0,22 m ²	0,30 m ²	0,22 m ²
			A / W = 490 mm. L / L = 500 mm. Al / H = 670 mm.
			18K



Ref. 3331
Brazo a pared / Wall-adaptor

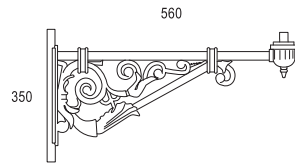

ACCESORIOS / ACCESSORIES

Incremento por accesorios / Rough price increase of accessories		€
Ref. 3331	Brazo a pared para luminarias sustentadas / Wall-adaptor for sustained lamps	95,20
Ref. 3335	Racor adaptador para columna de ø60mm / Reducing adapter for posts ø60mm	49,90
Ref. AM	Pintura especial ambiente marino / Special marine environment paint	120,00

OPCIONES / OPTIONS

Incremento por óptica / Rough price increase of optics		28 LEDs	40 LEDs
Ref. 3408	Óptica simétrica 80° / Symmetric optics 80°	3,20	4,80
Ref. 3407	Óptica asimétrica / Asymmetric optics	36,12	55,60

OPCIONES LED / LED OPTIONS	Ref. 83	Ref. 84	Ref. 85
CRI>70 / Temperatura de color / Colour temperature	3000°K	4000°K	5700°K
Osram Oslon SSL	•	•	•

ACCESORIOS / ACCESSORIES		€
Ref. 3390	Protector de sobretensión / Surge protector	19,00

N° LEDs	W	mA	Lúmenes / Lumens		
			3000°K	4000°K	5700°K
28	29,4w	350	3047	4116	4479
28	45,4w	530	4115	5544	5823
28	61,6w	700	5180	7000	7839
40	42w	350	4360	5880	6400
40	88w	700	7400	10000	11200

Incremento respecto al driver / Rough price increase of accessories	29,4w	42w	45,4w	61,6w	88w	
Ref. DR	Driver regulable 1 - 10v / Dimmable driver 1 - 10v	19,90	19,90	19,90	105,00	90,00
Ref. DRD	Driver regulable Dali / Dimmable driver Dali	90,00	115,00	30,00	30,00	55,00
Ref. DRP	Driver programable / Programmable driver	71,30	94,80	94,80	94,80	94,80
Ref. DRPNTC	Driver programable / Programmable driver	87,10	110,60	110,60	110,60	110,60
Ref. 4160	Driver para funcionam. a 12Vdc. / Driver for 12Vdc operation	15,00	15,00	-	25,00	15,00

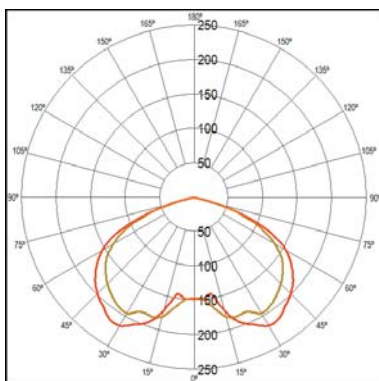

Regal sin cierre / without closing
FHS: 0,60%

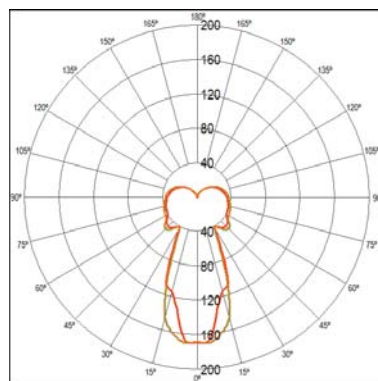

Regal con cierre mate / matt with closing
FHS: 24,9%

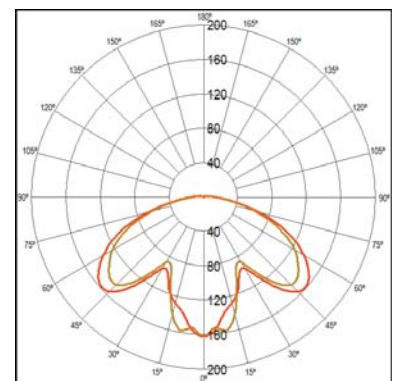

Regal con cierre prismático / prismatic with closing
FHS: 3,97%

REGAL

Grado de protección grupo óptico **IP65** / Grado de protección receptáculo porta-equipos **IP44**
Índice de protección antivandálico **IK08**

Material:	Cuerpo de la luminaria en aluminio con recubrimiento de pintura al horno.
Óptica:	Reflector de aluminio para lámparas en posición horizontal con cristal protector hermético. Se puede suministrar sin cierres, con cierre transparente o con cierre de policarbonato prismático.
Alimentación:	Todos los modelos incluyen equipos y lámparas adecuados.
Lámparas:	Usa lámparas de sodio de alta presión, de sodio blanco y de halogenuro metálico.
Instalación:	Acoplamiento para montaje sobre columnas. 3/4"
Colores:	Negro. Disponible en otros colores RAL bajo pedido.

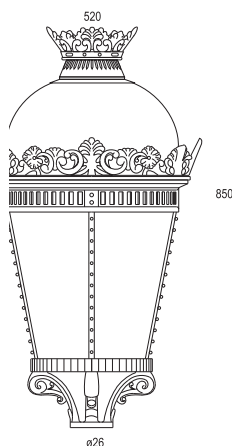

REGAL - LUMINARIA VACIA / REGAL - EMPTY LAMP		€
Ref. 3335 02 00	Luminaria vacía y sin cierres con reflector IP65 Empty lamp without protective closing IP65	292,60
Ref. 3335 02 01	Luminaria vacía con juego de cierres opal mate y reflector IP65 Empty lamp with protective matt closing and IP65 reflector	300,70
Ref. 3335 02 02	Luminaria vacía con juego de cierres policarbonato transparente IP65 Empty lamp with transparent polycarbonate closing and IP65 reflector	300,70

Regal - Sodio de alta presión - Sin cierres Regal - High Pressure Sodium - Without closing



Incluye luminaria, equipo y lámpara SODIO ALTA PRESIÓN
Includes control gear and HIGH PRESSURE SODIUM lamp

Ref.	Color / Colour	Lamp	Port./ L/H	W	€	lum.	RAEE lamp
3336 02 50 00	Negro / Black	SON-T	E-27	50W	396,62	0,70	0,30
3336 02 70 00	Negro / Black	SON-T	E-27	70W	397,30	0,70	0,30
3336 02 10 00	Negro / Black	SON-T	E-40	100W	398,78	0,70	0,30
3336 02 15 00	Negro / Black	SON-T	E-40	150W	411,00	0,70	0,30
3336 02 25 00	Negro / Black	SON-T	E-40	250W	424,74	0,70	0,30

Incluye luminaria, equipo y lámpara HQI /Includes control gear and HQI lamp

Ref.	Color / Colour	Lamp	Port./ L/H	W	€	lum.	RAEE lamp
3339 02 50 00	Negro / Black	CDO TT	E-27	50W	442,30	0,70	0,30
3339 02 70 00	Negro / Black	CDO TT	E-27	70W	446,50	0,70	0,30
3339 02 10 00	Negro / Black	CDO TT	E-40	100W	450,20	0,70	0,30

REGAL

Protection degree optic group **IP65** / Protection degree container equipment **IP44**
Impact protection index **IK08**

Material:	Body of the luminaire made in thermo painted aluminium.
Optics:	Aluminium reflector for lamps in horizontal position with sealed protector glass. It can be supplied without closure, with transparent closure or with prismatic polycarbonate closure.
Supply:	All models include control gear and lamps.
Lamps:	It uses high pressure sodium lamps, white sodium lamps and metallic halide lamps.
Installation:	Coupling for mounting in columns. 3/4"
Colours:	Black. It can be supplied in other RAL colours by request.



Regal - Sodio de alta presión - Policarbonato prismático Regal - High Pressure Sodium - Prismatic polycarbonate



Incluye luminaria, cierres, equipo y lámpara SODIO ALTA PRESIÓN
Includes closing, control gear and HIGH PRESSURE SODIUM lamp

Ref.	Color / Colour	Lamp	Port./ L/H	W	€	lum.	RAEE lamp
3336 02 50 02	Negro / Black	SON-T	E-27	50W	404,72	0,70	0,30
3336 02 70 02	Negro / Black	SON-T	E-27	70W	405,40	0,70	0,30
3336 02 10 02	Negro / Black	SON-T	E-40	100W	406,88	0,70	0,30
3336 02 15 02	Negro / Black	SON-T	E-40	150W	419,10	0,70	0,30
3336 02 25 02	Negro / Black	SON-T	E-40	250W	432,84	0,70	0,30

Incluye luminaria, cierres, equipo y lámpara HQI
Includes closing, control gear and HQI lamp

Ref.	Color / Colour	Lamp	Port./ L/H	W	€	lum.	RAEE lamp
3339 02 50 01	Negro / Black	CDO TT	E-27	50W	450,40	0,70	0,30
3339 02 70 01	Negro / Black	CDO TT	E-27	70W	454,60	0,70	0,30
3339 02 10 01	Negro / Black	CDO TT	E-40	100W	458,30	0,70	0,30



Grupo óptico IP65 con lámp. horizontal
Optic group IP65 with lamp horizontal

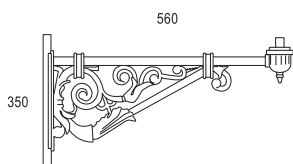

Ref. **3331**
Brazo a pared / Wall-adapter

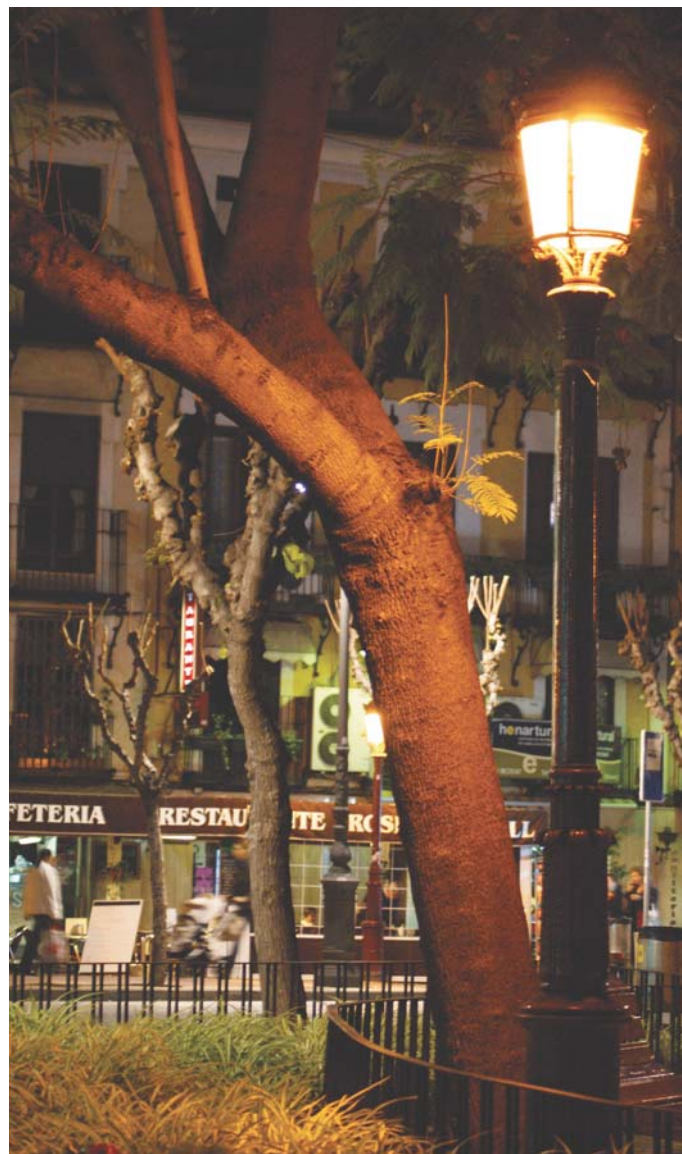
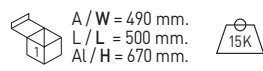
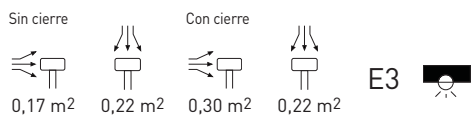
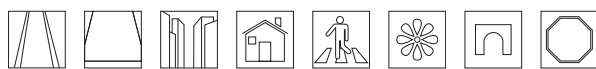

Regal - Sodio de alta presión - Policarbonato transparente
Regal - High Pressure Sodium - Transparent polycarbonate



Incluye luminaria, cierres, equipo y lámpara SODIO ALTA PRESIÓN
Includes closing, control gear and High Pressure SODIUM lamp

Ref.	Color / Colour	Lamp	Port./ L/H	W	€	lum.	RAEE lamp
3336 02 50 03	Negro / Black	SON-T	E-27	50W	404,82	0,70	0,30
3336 02 70 03	Negro / Black	SON-T	E-27	70W	405,50	0,70	0,30
3336 02 10 03	Negro / Black	SON-T	E-40	100W	406,98	0,70	0,30
3336 02 15 03	Negro / Black	SON-T	E-40	150W	419,20	0,70	0,30
3336 02 25 03	Negro / Black	SON-T	E-40	250W	432,94	0,70	0,30

Incluye luminaria, cierres, equipo y lámpara HQI
Includes closing, control gear and HQI lamp



Ref.	Color / Colour	Lamp	Port./ L/H	W	€	lum.	RAEE lamp
3339 02 50 03	Negro / Black	CDO TT	E-27	50W	450,50	0,70	0,30
3339 02 70 03	Negro / Black	CDO TT	E-27	70W	454,70	0,70	0,30
3339 02 10 03	Negro / Black	CDO TT	E-40	100W	458,40	0,70	0,30

ACCESORIOS / ACCESSORIES

Incremento por accesorios / Rough price increase of accessories	€
Ref. 3331 Brazo a pared para luminarias sustentadas Wall-adapter for sustained lamps	95,20
Ref. 3335 Racor adaptador para columna de ø60mm Reducing adapter for posts ø60mm	49,90

OPCIONES DE REGULACIÓN DOBLE NIVEL CON LÍNEA DE MANDO
DOUBLE LEVEL DIMMABLE WITH ADDITIONAL CONTROL WIRE OPTION

Incremento respecto a la luminaria NO regulable / Rough price increase of control gear	€
Ref. RLM70 Sodio alta presión / HQI 70W / High pressure sodium / HQI 70w	56,00
Ref. RLM100 Sodio alta presión / HQI 100W / High pressure sodium / HQI 100w	58,20
Ref. RLM150 Sodio alta presión / HQI 150W / High pressure sodium / HQI 150w	72,20
Ref. RLM250 Sodio alta presión / HQI 250W / High pressure sodium / HQI 250w	85,40

OPCIONES DE REGULACIÓN DOBLE NIVEL SIN LÍNEA DE MANDO
DOUBLE LEVEL DIMMABLE WITHOUT ADDITIONAL CONTROL WIRE OPTION

Incremento respecto a la luminaria NO regulable / Rough price increase of control gear	€
Ref. RSL50 Sodio alta presión / HQI 50W / High pressure sodium / HQI 50w	56,10
Ref. RSL70 Sodio alta presión / HQI 70W / High pressure sodium / HQI 70w	57,10
Ref. RSL100 Sodio alta presión / HQI 100W / High pressure sodium / HQI 100w	58,30
Ref. RSL150 Sodio alta presión / HQI 150W / High pressure sodium / HQI 150w	72,90
Ref. RSL250 Sodio alta presión / HQI 250W / High pressure sodium / HQI 250w	92,20

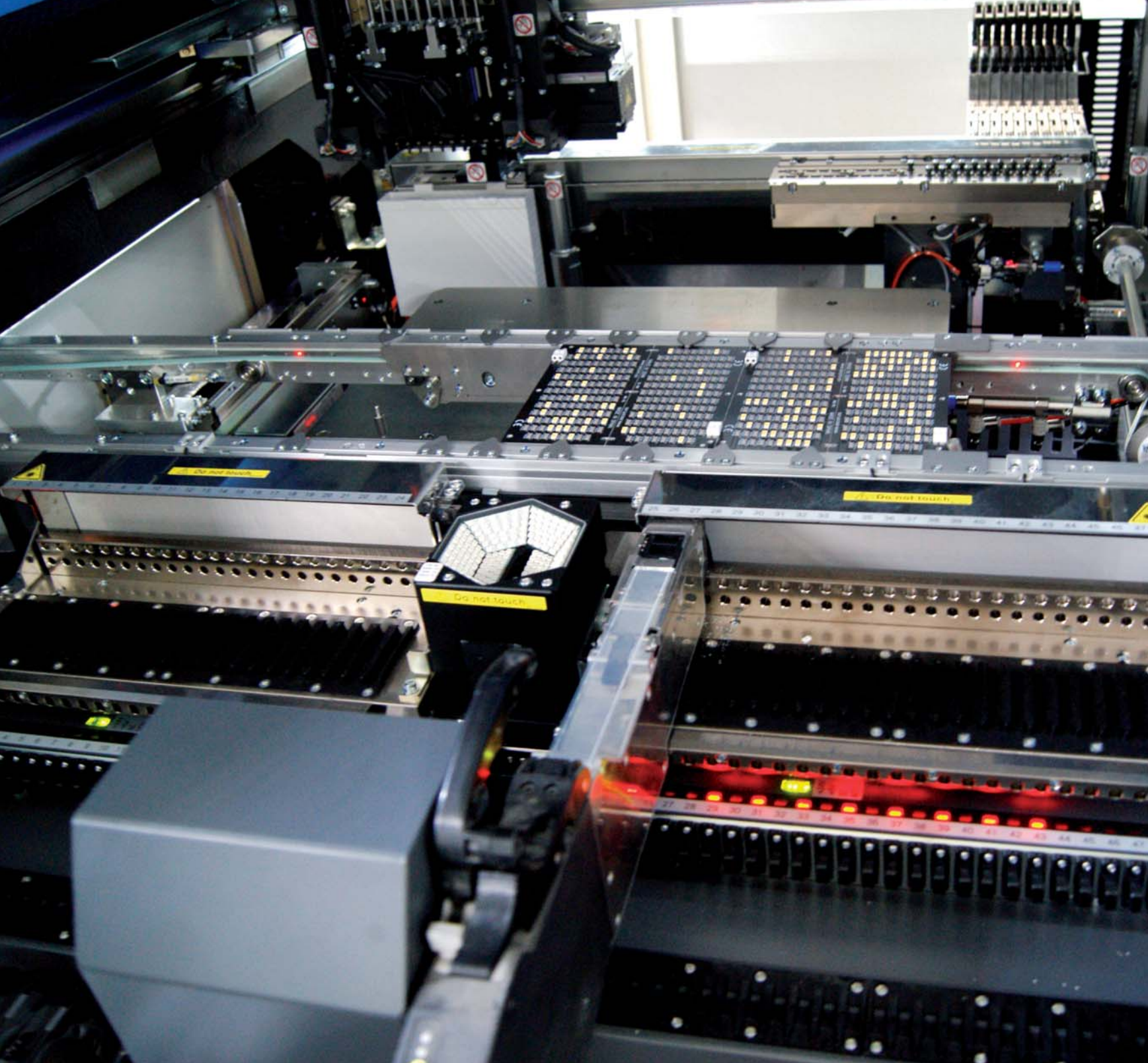

▶ GRUPOS ÓPTICOS
▶ OPTICS GROUPS



Grupos Ópticos LED

Permiten la sustitución rápida y eficiente de las lámparas convencionales en luminarias ya existentes. Se fabrican grupos ópticos LED para cualquier luminaria del mercado para realizar la sustitución previo envío de las luminarias a nuestras instalaciones.

Grupo óptico IP65 - URA LED Optic group IP65 - URA LED



Incluye herrajes, protector de policarbonato, disipadores, driver y 28 LED
Includes fittings, protection polycarbonate, heatsinks, driver and 28 LED

Ref.	Lamp	W	mA	Lum.	€
3410 28 29 85	LED	29,4w	350	4479	254,26
3410 28 45 85	LED	45,4w	530	5823	340,10
3410 28 61 85	LED	61,6w	700	7839	358,80

* Se suministra de manera estándar con lámpara 5700°K.

* Standardly supplied with 5700°K.

Incluye herrajes, protector de policarbonato, disipadores, driver y 40 LED
Includes fittings, protection polycarbonate, heatsinks, driver and 40 LED

Ref.	Lamp	W	mA	Lum.	€
3410 40 42 85	LED	42w	350	6400	374,10
3410 40 88 85	LED	88w	700	11200	390,92

* Se suministra de manera estándar con lámpara 5700°K.

* Standardly supplied with 5700°K.

Grupo óptico IP65 - REGAL LED Optical compartment IP65 - REGAL LED



Incluye herrajes, protector de policarbonato, disipadores, driver y 28 LED
Includes fittings, protection polycarbonate, heatsinks, driver and 28 LED

Ref.	Lamp	W	mA	Lum.	€
3411 28 29 85	LED	29,4w	350	4479	289,90
3411 28 45 85	LED	45,4w	530	5823	341,60
3411 28 61 85	LED	61,6w	700	7839	373,10

* Se suministra de manera estándar con lámpara 5700°K.

* Standardly supplied with 5700°K.

Incluye herrajes, protector de policarbonato, disipadores, driver y 40 LED
Includes fittings, protection polycarbonate, heatsinks, driver and 40 LED

Ref.	Lamp	W	mA	Lum.	€
3411 40 42 85	LED	42w	350	6400	388,50
3411 40 88 85	LED	88w	700	11200	399,90

* Se suministra de manera estándar con lámpara 5700°K.

* Standardly supplied with 5700°K.

LED Optical Compartment

They allow a quick and efficient replacement of conventional bulbs in pre-existing lamps. We manufacture LED headlights for any lamp existing, and it allow us to replace them in our installations.



Grupo óptico - ECODUT LED
Optical compartment - ECODUT LED



Incluye herrajes, disipadores, driver y 28 LED / Includes fittings, heatsinks, driver and 28 LED

Ref.	Lamp	W	mA	Lum.	€
3412 28 29 85	LED	29,4w	350	4479	292,10
3412 28 45 85	LED	45,4w	530	5823	322,40
3412 28 61 85	LED	61,6w	700	7839	333,40

* Se suministra de manera estándar con lámpara 5700°K.
* Standardly supplied with 5700°K.



Incluye herrajes, protector de policarbonato, disipadores, driver y 40 LED
Includes fittings, protection polycarbonate, heatsinks, driver and 40 LED

Ref.	Lamp	W	mA	Lum.	€
3412 40 42 85	LED	42w	350	6400	411,94
3412 40 88 85	LED	88w	700	11200	488,22

* Se suministra de manera estándar con lámpara 5700°K.
* Standardly supplied with 5700°K.



Grupo óptico - RIPA LED
Optic group - RIPA LED



Incluye herrajes, disipadores, driver y 28 LED / Includes fittings, heatsinks, driver and 28 LED

Ref.	Lamp	W	mA	Lum.	€
3413 28 29 85	LED	29,4w	350	4479	292,60
3413 28 45 85	LED	45,4w	530	5823	372,20
3413 28 61 85	LED	61,6w	700	7839	390,80

* Se suministra de manera estándar con lámpara 5700°K.
* Standardly supplied with 5700°K.



Incluye herrajes, disipadores, driver y 40 LED / Includes fittings, heatsinks, driver and 40 LED

Ref.	Lamp	W	mA	Lum.	€
3413 40 42 85	LED	42w	350	6400	441,20
3413 40 88 85	LED	88w	700	11200	517,50

* Se suministra de manera estándar con lámpara 5700°K.
* Standardly supplied with 5700°K.



Grupo óptico - RAY BEN LED
Optic group - RAY BEN LED



Incluye herrajes, disipadores, driver y 28 LED / Includes fittings, heatsinks, driver and 28 LED

Ref.	Lamp	W	mA	Lum.	€
3414 28 29 85	LED	29,4w	350	4479	293,20
3414 28 45 85	LED	45,4w	530	5823	371,20
3414 28 61 85	LED	61,6w	700	7839	390,80

* Se suministra de manera estándar con lámpara 5700°K.
* Standardly supplied with 5700°K.



Incluye herrajes, disipadores, driver y 40 LED / Includes fittings, heatsinks, driver and 40 LED

Ref.	Lamp	W	mA	Lum.	€
3414 40 42 85	LED	42w	350	6400	449,50
3414 40 88 85	LED	88w	700	11200	517,50

* Se suministra de manera estándar con lámpara 5700°K.
* Standardly supplied with 5700°K.



Condiciones generales de venta

1. Generales.

SECOM S.L. se reserva el derecho de realizar pequeñas variaciones en las medidas o características de los aparatos, mejoras en sus modelos, así como de anular cualquiera de ellos sin previo aviso.

SECOM S.L. no se hace responsable de los problemas derivados por las posibles erratas en las fotografías, medidas y/o datos que aparecen en el catálogo.

2. Garantía.

SECOM S.L. se responsabiliza de la calidad de sus luminarias siempre que se sigan las recomendaciones indicadas y declinará toda responsabilidad por la:

- Aplicación inadecuada del aparato o de las lámparas empleadas.
- Incorrecto suministro eléctrico.
- No seguir las instrucciones de instalación o mantenimiento.
- Agentes externos.

Todos los casos de reclamaciones sobre defectos ocultos serán atendidos conforme a la Ley 23/2003 sobre garantías de los bienes de consumo.

Las lámparas son consideradas como bienes consumibles y por lo tanto no están sujetas al periodo de garantía establecido en la Ley 23/2003.

La durabilidad de las luminarias dependerá:

Productos de Acero Inox.: Los productos de acero inoxidable de este catálogo están fabricados en material de alta calidad.

Sobre el acero inoxidable pueden aparecer pequeñas manchas como resultado del contacto con la atmosfera marina, ambientes húmedos, así como la cal proveniente del agua de los riegos. Este tipo de contaminación sobre el acero se eliminará con la aplicación de productos limpiadores que contengan ácido fosfórico.

Productos de aluminio: Nuestros artículos han sido protegidos con cromatización y acabados con pinturas de poliéster y su deterioro puede producirse por:

- Contacto continuado con aguas de alto porcentaje de sal o aguas ácidas contaminadas por abonos o insecticidas.
- La electrólisis producida por el contacto del aluminio con los tornillos de sujeción si son de hierro (se aconsejan de acero inoxidable).
- La corriente vagante existente en el terreno, únicamente evitable con una correcta toma-tierra.
- La no protección rápida del aluminio en el caso de verse arrancada la pintura por roce o golpe.

La responsabilidad de SECOM S.L. queda limitada al replazo, a la reparación, o al abono del producto defectuoso y al coste de envío de las muestra, no siendo extensible dicha responsabilidad a otros gastos que pudieran derivarse de la instalación de los productos tales como gastos de transporte, mano de obra, etc., ni a ningún otro daño o perjuicio directo o indirecto.

Para aplicaciones de garantía de 5,7 y 10 año consultar.

3. Plazos de entrega.

Los plazos de entrega se confirmarán en el momento de cursar el pedido y serán siempre a título orientativo por lo que los retrasos que pudiesen existir no implicarán la cancelación del pedido ni la imputación de penalizaciones.

4. Transporte.

En todo el territorio peninsular y para pedidos superiores a 400 € netos, los portes serán a cargo de SECOM S.L., realizándose por nuestro transporte habitual.

En las Islas Canarias los portes serán pagados para pedidos superiores a 1.200 €, realizándose por nuestro transporte habitual.

En el caso de entregas al extranjero los portes serán pagados para pedidos superiores a 1.000 € para Italia, 1.000 € para Francia y 400 € para Portugal.

En caso de que el transporte sea designado por el comprador, este irá a su cargo aun cuando el importe sea superior al mínimo estipulado.

5. Reclamaciones.

Las reclamaciones por diferencias en la cantidad, calidad u otros defectos de las mercancías suministradas no se admitirán pasados 24 Horas a partir de la fecha de recepción de las mismas.

Las reclamaciones derivadas de rotura de material causada por la agencia de transporte no se admitirán pasadas 24 horas, ya que es el plazo máximo permitido por las aseguradoras de las agencias.

6. Devoluciones.

SECOM S.L. no admitirá ninguna devolución de mercancía que previamente no haya sido comunicada y aceptada por escrito por SECOM S.L.

Todas las devoluciones tienen que ir acompañadas de la siguiente Documentación:

- Relación de material o producto devuelto
- Causa o motivo de la devolución
- Copia del albarán de la compra del material o producto

No se admitirán devoluciones de material no estándar solicitado por el cliente.

La decisión última de la aceptación de la devolución se tomará tras la comprobación de la mercancía a su recepción.

Las devoluciones de material en buen estado propiedad del cliente, se admitirán bajo las siguientes condiciones:

- Antigüedad del material menor a 30 días - 20% de depreciación
- Entre 30 días y 3 meses - depreciación del 30 %
- Entre 3 y 12 meses - depreciación del 50%
- Mayor de 12 meses - no serán abonadas

Las devoluciones se deberán realizar a portes pagados, salvo aquellas que se produzcan por causas de defectos en calidad o errores imputables a SECOM S.L. en cuyo caso se enviarán por la agencia indicada por el comercial de zona.

7. Cancelación de pedidos.

Una vez recibido un pedido en nuestras oficinas, de luminarias especiales o de luminarias que no sean de tecnología LED, y transcurridas 48 horas desde su recepción, éste no podrá ser cancelado sin previa autorización por escrito de Secom.

En el caso de que la cancelación sea autorizada esta tendrá un cargo del 20% del pedido.

8. Entrada en vigor.

15 de Enero del 2016.

Esta tarifa anula cualquier tarifa de precios anterior.

Terms and conditions of sale

1. General.

SECOM S.L. reserves the right to perform modifications on the measures and characteristics of the fittings, improvements on his models, and to eliminate the supply of any of them without previous notice.

SECOM S.L. is not responsible of any problems caused by possible mistakes in the pictures, measures and/or data which appear in the catalogue.

2. Guarantees.

SECOM, S.L. is responsible for the quality of the fittings if the recommendations are followed and declines all the responsibilities derived from:

- Wrong application of the fitting or lamps.
- Wrong power supply.
- Wrong use of fitting instructions and maintenance.
- External agents to SECOM.

All the claim cases regarding hidden defects will be handled in accordance with the Law 23/2003 regarding guarantees on consumer goods.

All the lamps are considered as non-recoverable items and so they are not subject to the guarantee period defined by the Law 23/2003.

The durability of the fittings depends on:

Stainless Steel Product: the stainless steel products in this catalogue are manufactured with high-quality materials.

On the stainless steel could appear some little shadings due to the contact of the sea atmosphere, humid or wet environment, as well as the lime arising from the irrigation water. This type of contamination on the stainless steel will be eliminated/reduced by the application of cleaner products containing phosphoric acid.

Aluminium Products: our items are protected by chromate process and finished with polyester painting and their deterioration could be caused by:

- Continuous contact with high-percentage salt water or acid water contaminated by fertilisers or insecticides.
- The electrolysis produced by aluminium contact with bolts if they are made of iron (on advice they should be of stainless steel).
- The stray current running through the land, only avoidable with a correct earth-connection.
- A late protection of the aluminium in the case of scratched painting due to a crack or rub-out.

For assurance applications 5, 7 and 10 years consulting.

3. Delivery time.

The delivery time will be confirmed at the time of placing the order and will always be always be as orientative guide, so delays that may exist not imply the cancellation of the order or the imputation of penalties.

4. Transport.

In the case of abroad delivery the transport will be charged to SECOM S.L. for orders upper to 1.000 € for Italy, 1.000 € for France, 400 € for Portugal. (For other destinations ask conditions)

However the customer can choose to nominate his agency, but in that case, even if the total amount of the order is upper to the minimum, the client will be totally responsible for the amount of transport.

5. Claims.

Claims for difference in quantity, quality or other types of defect/fault of the

delivered goods will not be accepted after 24 hours from the delivery date.

Claims for breakages of the material due to the transport agency will not be admitted after 24 hours, as it is the maximum time allowed for the insurance companies.

6. Returns.

SECOM S. L. not accept any return of goods that has not previously been reported and accepted in writing by SECOM SL.

All returns must have included the following documentation:

- List of material or product returned
- Cause or reason for return
- A copy of the invoice for the purchase of material or product

No standard items returns will not be accepted.

The final decision will be taken after checking the returned goods.

The returns of material in good condition, will be accepted under the following conditions:

- Antiquity of the material less than 30 days - 20% depreciation
- Between 30 days and 3 months - 30 % depreciation.
- Between 3 and 12 months - 50% depreciation.
- More than 12 months no refunds.

Transport costs for returns will be paid by the customer, except those which may result from causes of defects in quality or errors attributed to SECOM SL, in which case it will be sent by the agency indicated by the area's commercial agent.

7. Entry into force.

Once we receive the Purchase Order, and it's related to customized luminaires or NOT LED fittings and after 48 hours after sending the confirmation, the order could not be cancelled unless written authorization by SECOM.

In case of this authorization, we'll charge 20% of the total amount as depreciation value.

8. Entry into force.

15th of January 2016.

This catalogue/price list nullifies any previous price list.

De acuerdo al Art.12 de la Ley 11/1997 de envases y residuos de envases, el poseedor final de los residuos de envases y envases usados, será el responsable de la entrega en condiciones adecuadas de separación para su correcta gestión ambiental a un recuperador, reciclador o valorizador autorizado.

According to Art.12 of the Law 11/1997 on packaging and packaging waste, the final holder of packaging waste and used packaging, will be responsible for delivering in an adequate separation conditions for its correct environmental management to a recovery, recycling or authorized valuer.



Polígono Industrial La Estrella, C/ Marte 18-21
30500 Molina de Segura (Murcia) Spain
Tlf.: 968 801 211 - Fax 968 891 048
Buzón de Correos nº 11

Dpto. Exportación
Tlf.: ++34-968 801 688 - Fax: ++34-968 891 048



www.secom.es

